



Mail Safe Box Equip

joma.es



2022 / 2023

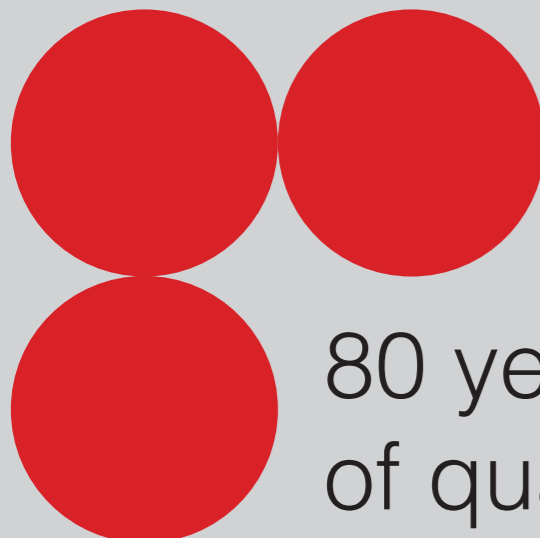

80 years of quality



JOMA
QUALITY
GUARANTEE
**MADE IN
SPAIN**

**100% DISEÑADO
Y FABRICADO EN
VITORIA-GASTEIZ (ESPAÑA)**

100% DESIGNED AND
MANUFACTURED IN
VITORIA-GASTEIZ (SPAIN)



ISO 9001:2015

Sistema de gestión que cumple con los requisitos de calidad de la Norma ISO 9001:2015 para la fabricación de los productos Joma.

Management system that complies with the quality requirements of the Standard ISO 9001:2015, for the manufacturing of all Joma products.

1942

2022

Joma forma parte de
Joma is part of



80 YEARS OF QUALITY

 **1942**

Jose María Gallastegui, junto con otros socios funda Jose María Gallastegui y CIA SA bajo la marca JOMA como taller de fabricación y comercialización de candados para bicicletas.

MR. Jose María Gallastegui, together with other partners, founds Jose María Gallastegui y CIA SA under the JOMA brand as a factory for the manufacture and sale of bicycle locks.

 **1973**

Incorporación de la segunda generación en la gestión empresarial.

Incorporation of the second generation in business management.

2001



JOMA se convierte en el líder en la fabricación y comercialización de cajas de caudales a nivel europeo.

JOMA becomes the leader in the manufacture and sale of cash boxes at European level.

2014



Traslado de la planta productiva de Mondragón a Legutiano, que permite aumentar las capacidades productivas.

We move our plant from Mondragón to our new factory in Legutiano, which allows us to increase our production levels.

 **2022**

Con la incorporación de la tercera generación familiar refuerza la apuesta por la digitalización y se ratifican los valores de calidad, sostenibilidad y producción local que han caracterizado a JOMA durante sus 80 años de historia.

With the incorporation of the third family generation, the commitment to digitization is reinforced and the values of quality, sustainability and local production that have characterized JOMA during its 80 year history, are ratified.

JOMA 

1960 

JOMA consigue la homologación de CORREOS para los buzones postales.

JOMA obtains the National Post Office approval for postal mailboxes.



1980 

Mediante la sociedad HAMAEX (asociación exportadora de empresas del Alto Deba) se incrementan y se consolidan las exportaciones a diferentes países europeos y américa.

Through HAMAEX (Association of several export manufacturer companies in the Baque Country), we consolidate our sales to Europe and North and South American countries.

2008 joma urban

Creación de la división de mobiliario urbano, JOMA URBAN, como diseñador y fabricante de espacios sociales para que formen parte de nuestro día a día.

Creation of the urban furniture division, JOMA URBAN. We design and manufacture social spaces that form part of our daily lives.



2019  **JomaBox**

Lanzamiento de la división de buzones inteligentes JOMABOX para dar respuesta al incremento del comercio online y facilitar a sus usuarios la recepción de paquetes en casa.

Launch of the JOMABOX smart mailbox division to respond to the increasing "e-commerce", making very easy for end users to receive their parcels at home.



JomaBox

Buzones de paquetería inteligentes / Smart parcel boxes



JomaMail

Buzones de correo / Mailboxes

BUZONES DE PAQUETERÍA MECÁNICOS / MECHANICAL PARCEL BOXES

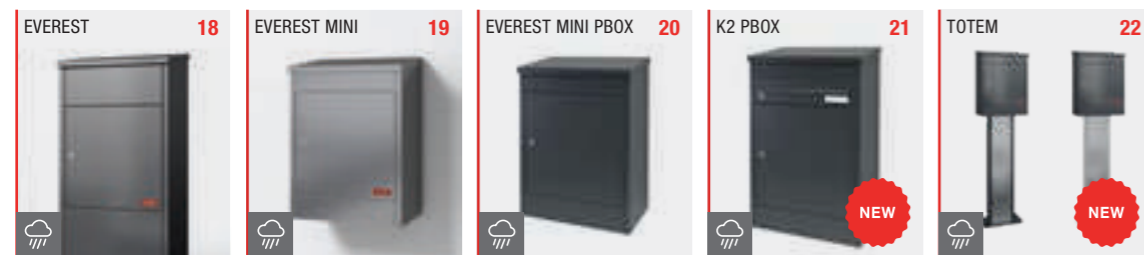

BUZONES COMUNITARIOS / COMMUNITY MAILBOXES



BUZONES 100 % ANTICORROSIÓN / 100% ANTI-RUST MAILBOXES



BUZONES ALUMINIO / ALUMINIUM MAILBOXES

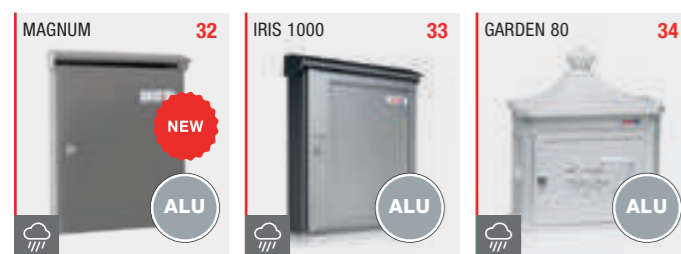

BUZONES ACERO / STEEL MAILBOXES

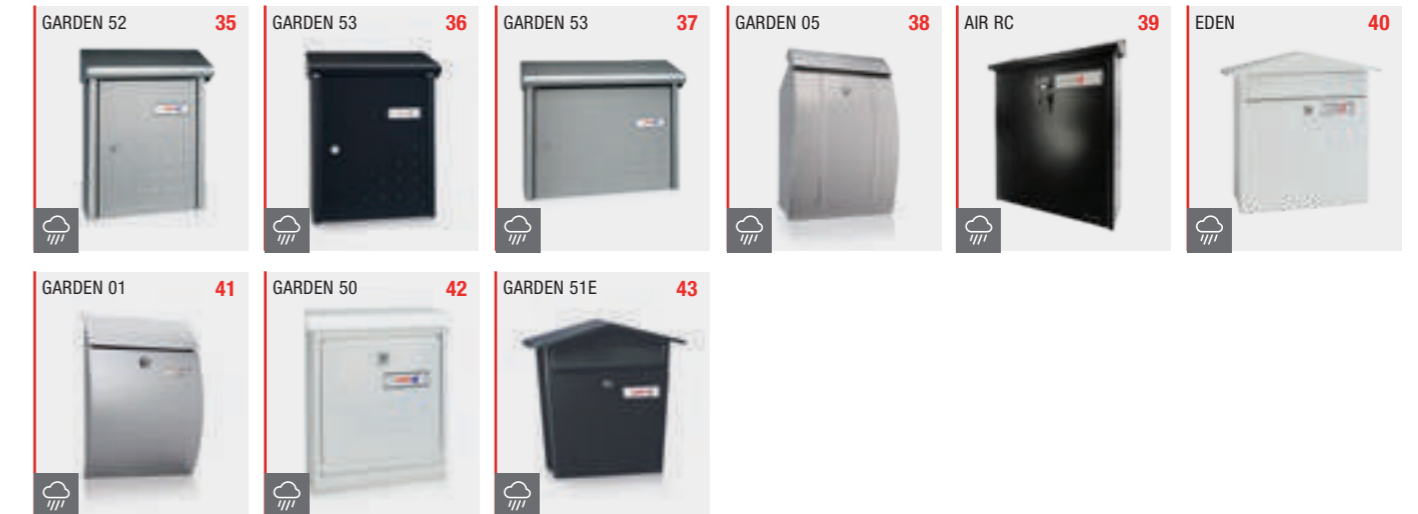

BUZONES PLÁSTICO ABS / ABS PLASTIC MAILBOXES



KIT FIJACIÓN EXTERIOR / OUTDOOR FIXING KIT



RECOGECARTAS / REAR RETRIEVAL MAILBOXES



BOCACARTAS / LETTERPLATES



EMERGENCIA / EMERGENCY



ARMARIOS DE LLAVES / KEY CABINETS



CAJAS DE CAUDALES / CASH BOXES



CASILLEROS / LOCKERS

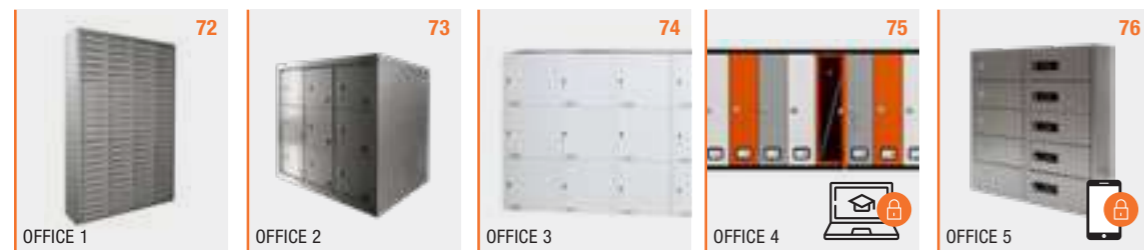

EQUIPAMIENTO / EQUIPMENT

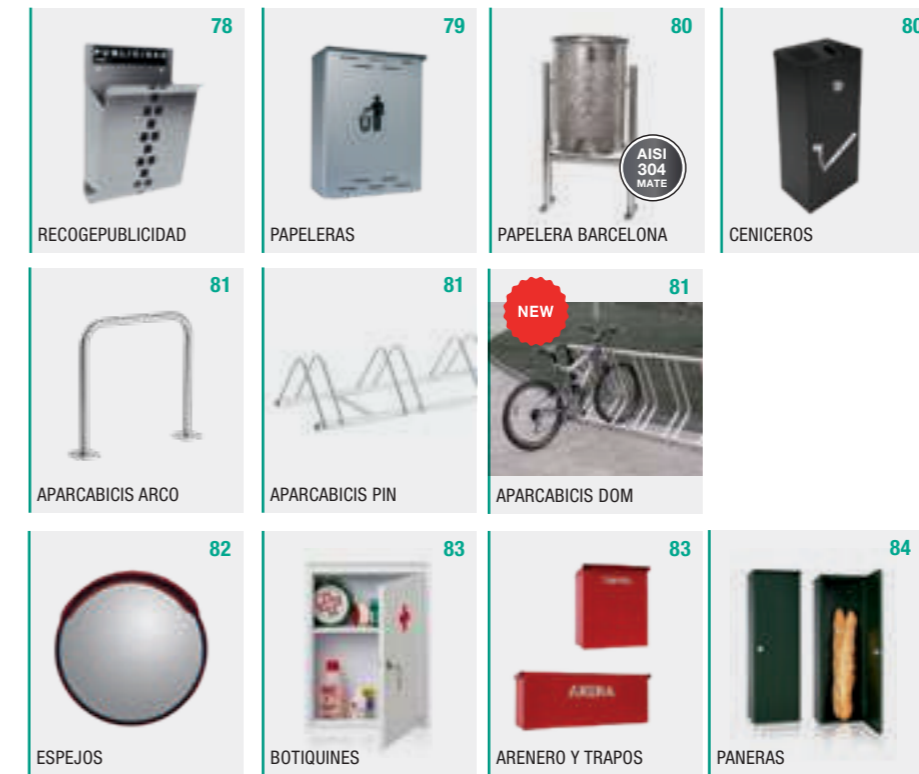

SISTEMAS DE INFORMACIÓN / INFORMATION SYSTEMS

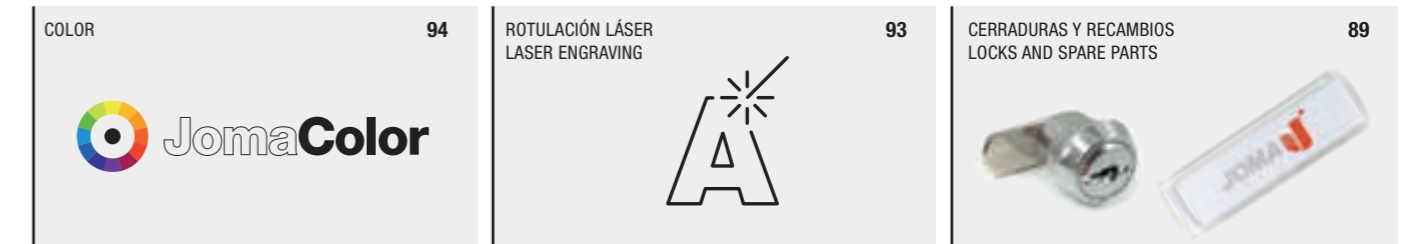

Información técnica

Technical information

PROPIEDADES / PROPERTIES

Gran estanqueidad Watertight	Antivandálico Anti-theft	
Pintura antihuellas Anti-fingerprint paint	Pintura texturada Textured paint	
Producto para INTERIOR y EXTERIOR Product for INDOOR and OUTDOOR		Producto para INTERIOR o EXTERIOR BAJO CUBIERTA Product for INDOOR or OUTSIDE UNDER COVER

DIMENSIONES / DIMENSIONS

Tamaño buzón Mailbox dimension	Pequeña capacidad Small capacity	Mediana capacidad Medium capacity	Gran capacidad Big capacity
Capacidad bocacartas Letterplates capacity	Din A4	Din A5	Apertura puerta Door opening
		Apertura lateral Side opening	Apertura vertical Vertical opening

MATERIALES / MATERIALS

Acero Inoxidable AISI 304 Mate Stainless Steel Matt AISI 304 RECOMENDADO PARA EXTERIOR RECOMMENDED FOR OUTDOOR	Acero Inoxidable Brillo AISI 430 Stainless Steel Gloss AISI 430 RECOMENDADO PARA EXTERIOR RECOMMENDED FOR OUTDOOR	
Acero Steel	Acero Electrocincado Electrogalvanized Steel	Acero Galvanizado Galvanized Steel
Aluminio Aluminium	Aluminio Anodizado Anodized Aluminium	Plástico ABS ABS plastic

PERSONALIZACIÓN / CUSTOMIZATION

CERRADURA PERSONALIZABLE CUSTOMIZABLE LOCK Tenemos diversas soluciones para el sistema de cierre de nuestros productos. We have several locking solutions for your box.	GRABACIÓN LÁSER LASER ENGRAVING Podemos personalizar tu producto mediante grabación láser. We can customize your product with laser engraving.	JomaColor Elige entre nuestra gama de 16 colores y acabados o... ¡pídenos el que realmente quieres! Choose between our 16 standard colors and finishes... or ask for the one you really want!
---	--	--



Marine

MÁXIMA PROTECCIÓN ANTE LA CORROSIÓN.

MAXIMUM PROTECTION AGAINST CORROSION.

Este nuevo acabado da una máxima garantía anticorrosión. Este tratamiento, supera ampliamente los ensayos de corrosión Cámara de niebla Salina (UNE-EN ISO 9227) con resultados muy por encima de las exigencias normativas de la Norma Europea NE EN13724.

This new finish gives a maximum corrosion protection. This treatment, far exceeds the corrosion test in saline Fog Chamber UNE EN ISO 9227), with much higher results than the requirements of the European Standard EN13724.

Picking

Todos los artículos identificados con el símbolo PICKING ● están disponibles en stock para servicio inmediato.

All items marked with PICKING ● symbol are available in stock for immediate shipping.



JomaBox

Buzones de paquetería inteligentes

Smart parcel boxes

¿Qué son los buzones inteligentes?

What is a smart mailbox?

¿Cómo funciona?

HOW IT WORKS



jomabox.com

Seguro que nunca te has quedado en casa esperando al cartero. El cartero simplemente la deja en tu buzón y tú recoges la carta cuando llegas. Pero con los paquetes es otra historia.

¿Te gustaría que fuese tan sencillo como recoger una carta?

Para eso llega JomaBox. El buzón inteligente instalado en tu portal que te permite recibir tus pedidos online sin tener que estar en casa.

You've surely never sat at home waiting for the mail to come. The mail carrier just leaves the mail in your mailbox and you pick it up when you get home. But packages are a different story.

Would you like it to be as easy as getting a letter?

That's why JomaBox is here. A smart mailbox installed in the entrance of your building lets you receive online orders while you're not at home.

Ventajas

- La entrega garantizada en el 100% de los casos** se traduce en comodidad y tranquilidad para el usuario.
- Estética y forma adaptada a tu edificio.** Los buzones pueden colocarse en módulos a una o dos alturas o en agrupaciones junto con los buzones tradicionales.
- 24/7. Los buzones están operativos en todo momento**, para entregas y recogidas, permitiendo operar incluso por la noche, los 365 días del año.
- Acceso sencillo y controlado** al portal a transportistas autorizados.
- Producto adaptado a la nueva norma europea de estandarización** de Smart Lockers UNE CEN / TS 17457 que garantiza la compatibilidad futura del sistema.
- Contribuye a un mundo mejor mediante tu aportación a una **logística más eficiente y reduce la huella de carbono.**
- No requiere **ni WIFI ni instalación eléctrica.**

Benefits

- Guaranteed delivery 100% of the time** means convenience and peace of mind for users.
- Appearance and shapes adapted to your building.** The mailboxes can be installed in modules with one or two rows or in groups next to traditional mailboxes.
- 24/7. The mailboxes are operative at all times for deliveries** and pick up and they can even operate at night, 365 days a year.
- Authorized haulers have **easy and controlled access** to the entrance.
- The product conforms to the new Smart Lockers UNE CEN / TS 17457 European standard** that ensures the future compatibility of the system.
- Play a part in a better world by helping **make logistics more efficient and reducing the carbon footprint.**
- Does not require Wi-Fi or electrical wiring.**



JomaBox App + Smart Lock

Disponemos de nuestra App llavero para que el usuario pueda realizar las recogidas de sus compras. Con ella los usuarios podrán asociarse a los buzones inteligentes de su comunidad de manera autónoma.

We have a key chain app so users can pick up their purchases. With the app users can associate their building's smart mailboxes independently.



Todo en uno

Recibe y recoge todo desde el mismo sitio.

All-in-one: Receive and pick up everything in the same place.

Recibe tus paquetes

La forma más segura de que siempre haya "alguien" en casa.

Package Receipt: The safest way to always have "someone" home.

¡Parece magia!

Acerca tu dispositivo a la cerradura y ¡táchán! se desbloquea sola.

It seems like magic! Bring your device close to the lock and BING! it opens by itself.

Múltiples aplicaciones / Multiple applications

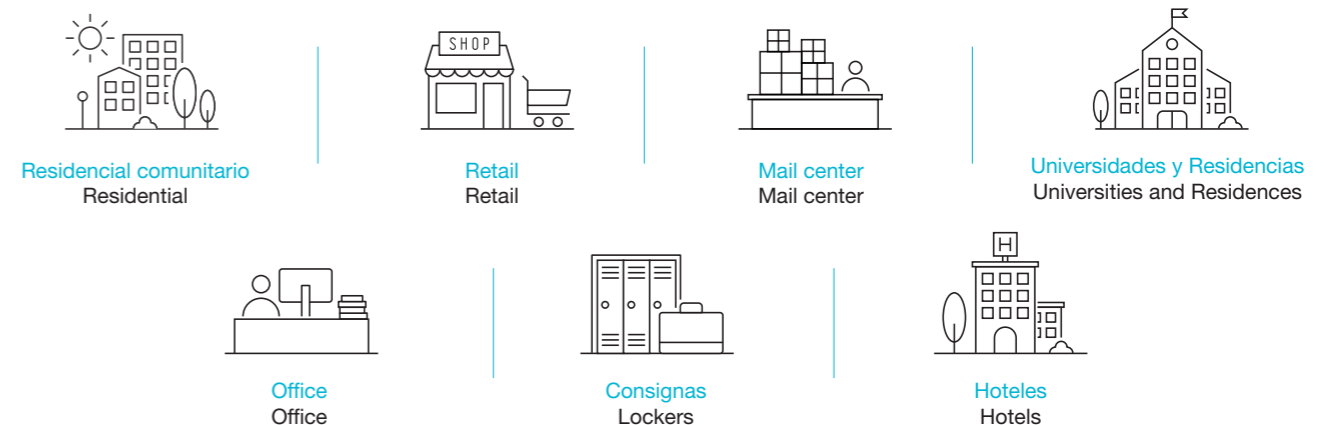



NEW

POD

Digitaliza tu vivienda unifamiliar con la instalación de un buzón inteligente POD para recepción de paquetería.

Digitalise your single family home by installing a POD smart mailbox to receive packages.



JOMABOX APP



CERRADURA SMART

Entrega y recogida de paquetes con el móvil, mediante la sencilla app jomabox.

SMART LOCK

Delivery and collection of parcels with the mobile, through the simple JomaBox App.



RECEPCIÓN Y DEVOLUCIÓN

Permite la recepción y devolución de múltiples paquetes.

RECEPTION AND RETURN

It allows the reception and return of multiple parcels.



SEGURO

Recibe los paquetes de forma segura. Antivandálico. Robusta puerta de acero de 1,2 mm de espesor.

SAFE

Receive parcels safely. Anti-theft. Robust 1.2 mm thick steel door.



POD

Buzón inteligente para la recepción de paquetería. Smart parcel box for parcel reception.



POD K2

Incorpora buzón independiente para la recepción de correo. Includes separate mailbox for receiving mail.



POD  

Capacidad / Capacity

 **40 l**

Medidas máximas de paquetes
Maximum parcel dimensions

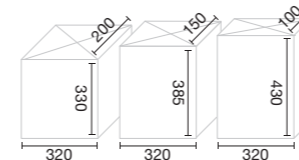

Dimensiones / Dimensions

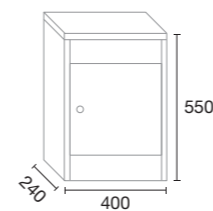

NEW



Smart lock

REF.	EAN	ACABADO / FINISH
POEMGES	8413612192162	Gris antracita / Anthracite grey
POEMES	8413612192186	JomaColor  (Mínimo / Minimum: 1 ud)

JOMA QUALITY GUARANTEE
MADE IN SPAIN

POD K2  

Capacidad / Capacity

 **40 l**

Medidas máximas de paquetes
Maximum parcel dimensions

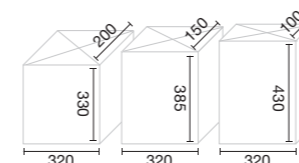

Dimensiones / Dimensions

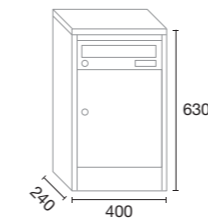

NEW



Buzón de paquetería + buzón de correo



Smart lock

REF.	EAN	ACABADO / FINISH
POK2GES	8413612192346	Gris antracita / Anthracite grey
POK2EES	8413612192360	JomaColor  (Mínimo / Minimum: 1 ud)

JOMA QUALITY GUARANTEE
MADE IN SPAIN



PAAK

Nuestra solución más ágil para instalaciones rápidas y sencillas consistente en módulos remontables.

JOMABOX APP



COLOR / P. 94



JOMA
QUALITY
GUARANTEE
MADE IN
SPAIN



CERRADURA SMART

Entrega y recogida de paquetes con el móvil, mediante la sencilla app jomabox.

SMART LOCK

Delivery and collection of parcels with the mobile, through the simple JomaBox App.



SEGURO

Recibe los paquetes de forma segura. Antivandálico. Robusta puerta de acero de 1,2 mm de espesor.

SAFE

Receive parcels safely. Anti-theft. Robust 1.2 mm thick steel door.



RECEPCIÓN Y DEVOLUCIÓN

Permite la recepción y devolución de múltiples paquetes.

RECEPTION AND RETURN

It allows the reception and return of multiple parcels.



SISTEMA MODULAR

Sin límite, se pueden añadir más módulos si fuera necesario.

MODULAR SYSTEM

No limit, more boxes can be added if necessary.

Módulos PAAK Modules

2L



3M



1S1M1L

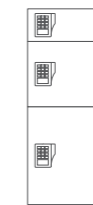

2S2M



2M2S



4S1M



1M4S

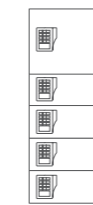

1XL



1XXL



MEDIDAS TOTALES DE CADA CONJUNTO DE MÓDULOS
TOTAL MEASUREMENTS OF EACH SET OF MODULES
990 x 420 x 350
(1XXL: 990 x 550 x 350)

MODULO / MODULE	DIMENSIONES / DIMENSIONS	CAPACIDAD / CAPACITY (L)
S	165 x 420 x 350	22
M	330 x 420 x 350	45
L	495 x 420 x 350	67
XL	990 x 420 x 350	135
XXL	990 x 550 x 350	178

Acabados Finishes



Blanco



Arena



Plata



Antracita



Personalizable

ACABADO/FINISH	PAAK 2L	PAAK 3M	PAAK 1S1M1L
Blanco / White	PA2LBEB	PA3MBEB	PA1SBEB
Arena / Sand	PA2LAEB	PA3MAEB	PA1SAEB
Plata / Silver	PA2LPEB	PA3MPEB	PA1SPEB
Antracita / Anthracite	PA2LGEB	PA3MGEB	PA1SGEB
JomaColor	PA2LEEB	PA3MEEB	PA1SEEB
	PAAK 2S2M	PAAK 2M2S	PAAK 4S1M
Blanco / White	PA2SBEB	PA2MBEB	PA4PBEB
Arena / Sand	PA2SAEB	PA2MAEB	PA4PAEB
Plata / Silver	PA2SPEB	PA2MPEB	PA4PPEB
Antracita / Anthracite	PA2SGEB	PA2MGEB	PA4PGEB
JomaColor	PA2SEEB	PA2MEEB	PA4PEEB
	PAAK 1M4S	PAAK 1 XL	PAAK 1 XXL
Blanco / White	PA1MBEB	PA1XLBEB	PA1XXBEB
Arena / Sand	PA1MAEB	PA1XLAEB	PA1XXAEB
Plata / Silver	PA1MPEB	PA1XLPEB	PA1XXPEB
Antracita / Anthracite	PA1MGEB	PA1XLGEB	PA1XXGEB
JomaColor	PA1MEEB	PA1XLEEB	PA1XXEEB

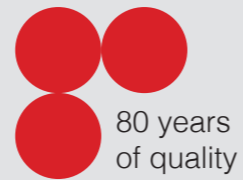

Solicite su copia del catálogo de comunidad 2022

Request your copy of the 2022 Community catalogue

DIN A4 | 95012 · DIN A5 | 95011



BUZONES Y SOLUCIONES DE PAQUETERÍA INTELIGENTES PARA COMUNIDAD

MAILBOXES AND SMART PARCEL BOXES FOR COLLECTIVITIES



Buzones para correo postal

Mailboxes

EVEREST



REF. 19220 ●
Pintura INOX / INOX Paint
EAN: 8413612192209

REF. 24731 ●
Gris Forja / Forging Grey
EAN: 8413612247312

Dispone de trampa antipesca, mayor seguridad.

Anti-theft device to prevent fishing.



Soporte para enterrar para el buzón de paquetería Everest.
Support to be buried for Everest parcel box.

REF. 24776 ●
Soporte Everest / Everest Support
EAN: 8413612247763

JOMA QUALITY GUARANTEE
MADE IN SPAIN

100% DISEÑO Y FABRICADO EN VITORIA-GASTEIZ (ESPAÑA)
100% DESIGNED AND MANUFACTURED IN VITORIA-GASTEIZ (SPAIN)

AG

PUERTA Y CUERPO
DOOR AND BOX

Buzón de paquetería preparado para la recepción de múltiples paquetes, periódicos y correo hasta 50 l de capacidad.

Parcel box prepared to collect several parcels, newspapers and mail up to 50 l of capacity

PERSONALIZACIÓN / CUSTOMIZATION



P. 94

MÍNIMO/MINIMUM: 5 uds.

REF. JOMACOLOR: 24732

DIMENSIONES / DIMENSIONS

Capacidad / Capacity **50 l**

Medidas máximas de paquetes
Maximum parcel dimensions

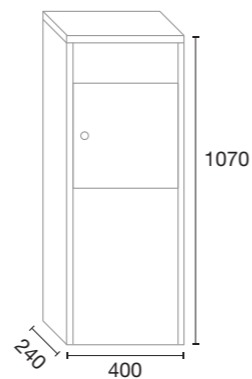
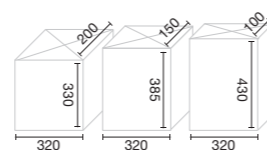

REPUESTOS / SPARE PARTS

CERRADURA / LOCK: REF. 51016P

EVEREST MINI



REF. 19201 ●
Pintura INOX / INOX Paint
EAN: 8413612192018

REF. 19200 ●
Gris Forja / Forging Grey
EAN: 8413612192001



Soporte TOTEM support

P. 22



JOMA QUALITY GUARANTEE
MADE IN SPAIN

100% DISEÑO Y FABRICADO EN VITORIA-GASTEIZ (ESPAÑA)
100% DESIGNED AND MANUFACTURED IN VITORIA-GASTEIZ (SPAIN)

AG

PUERTA Y CUERPO
DOOR AND BOX

Versión reducida del buzón de paquetería Everest para ubicaciones de espacio reducido.

Reduced version of Everest parcel box for space less installations.

PERSONALIZACIÓN / CUSTOMIZATION



P. 94

MÍNIMO/MINIMUM: 5 uds.

REF. JOMACOLOR: 19204

DIMENSIONES / DIMENSIONS

Capacidad / Capacity **20 l**

Medidas máximas de paquetes
Maximum parcel dimensions

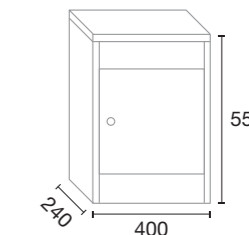
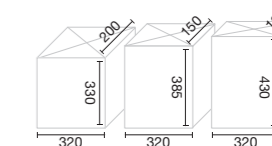

Soporte para colgar incluido.
Support for hanging included.



REPUESTOS / SPARE PARTS

CERRADURA / LOCK: REF. 51016P



EVEREST MINI PBOX



REF. 19210
Gris Forja / Forging Grey
EAN: 8413612192100

REF. 19211
Pintura INOX / INOX paint
EAN: 8413612192117

JOMA
QUALITY
GUARANTEE
**MADE IN
SPAIN**

**100% DISEÑO
Y FABRICADO EN
VITORIA-GASTEIZ (ESPAÑA)**
100% DESIGNED AND
MANUFACTURED IN
VITORIA-GASTEIZ (SPAIN)



PUERTA Y CUERPO
DOOR AND BOX

Versión con cerradura PBox para instalaciones con espacio reducido.

Reduced version of Everest parcel box for space less installations with PBox lock.

PERSONALIZACIÓN / CUSTOMIZATION



P. 94

MÍNIMO/MINIMUM: 5 uds.

REF. JOMACOLOR: 19214

DIMENSIONES / DIMENSIONS

Capacidad / Capacity  **20 l**

Medidas máximas de paquetes
Maximum parcel dimensions

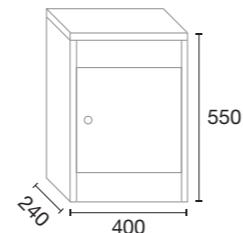
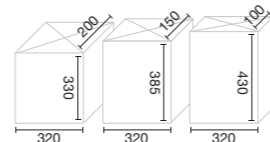

REPUESTOS / SPARE PARTS

CERRADURA / LOCK: REF. 51081

Soporte para colgar incluido.
Support for hanging included.



Soporte TOTEM
TOTEM support

P. 22

PBOX lock

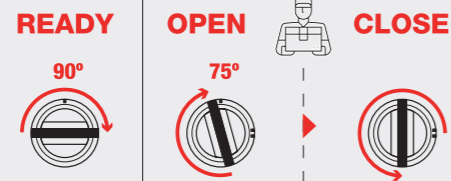

K2 PBOX



REF. 19230
Gris Forja / Forging Grey
EAN: 8413612192308

JOMA
QUALITY
GUARANTEE
**MADE IN
SPAIN**

**100% DISEÑO
Y FABRICADO EN
VITORIA-GASTEIZ (ESPAÑA)**
100% DESIGNED AND
MANUFACTURED IN
VITORIA-GASTEIZ (SPAIN)



PUERTA Y CUERPO
DOOR AND BOX

Box + buzón para pared, con techo fijo que ofrece flexibilidad en la recepción de paquetería y correo.

Mailbox + Parcel box, all in one.

PERSONALIZACIÓN / CUSTOMIZATION



P. 94

MÍNIMO/MINIMUM: 5 uds.

REF. JOMACOLOR: 19232

DIMENSIONES / DIMENSIONS

Capacidad / Capacity  **40 l**

Medidas máximas de paquetes
Maximum parcel dimensions

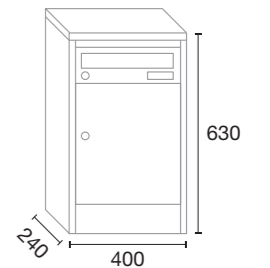
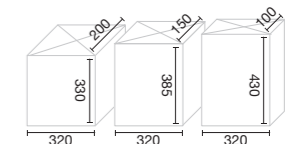

REPUESTOS / SPARE PARTS

TARJETERO / NAMEPLATE: REF. 03171TAR
CERRADURA / LOCK: REF. 51081



Soporte TOTEM
TOTEM support

P. 22

PBOX lock

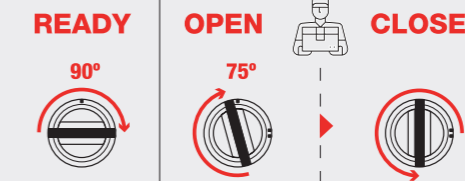

TOTEM



NEW



Gris forja-Pintura INOX
Forging grey-INOX paint

Pintura INOX
INOX paint

Gris forja
Forging grey

ACABADO / FINISH	ENTERRAR / BURIED	ATORNILLAR / SCREWED
Gris forja / Forging grey	19250	19255
Pintura INOX / INOX paint	19251	19256
Gris forja- Pintura INOX / Forging grey-INOX paint	19252	19257
JomaColor 	19253	19206

JOMA
QUALITY
GUARANTEE
**MADE IN
SPAIN**

**100% DISEÑO
Y FABRICADO EN
VITORIA-GASTEIZ (ESPAÑA)**
100% DESIGNED AND
MANUFACTURED IN
VITORIA-GASTEIZ (SPAIN)

AG TODO
ALL

Soporte para los buzones de paquetería. Para enterrar o atornillar a suelo.

Support for parcel boxes. To be buried or to be screwed to the ground.

PERSONALIZACIÓN / CUSTOMIZATION



MÍNIMO/MINIMUM: 5 uds.

DIMENSIONES / DIMENSIONS

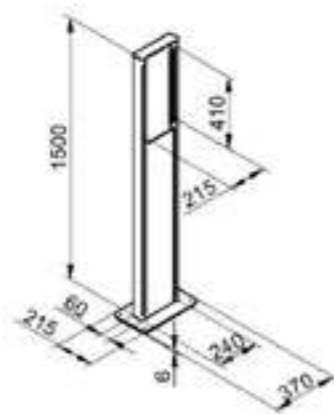

HALL 10

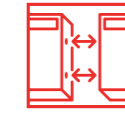

Opción de unión lateral. Dispone de agujeros.

Lateral union option. Holes available for lateral fixing.

JOMA
QUALITY
GUARANTEE
**MADE IN
SPAIN**

**100% DISEÑO
Y FABRICADO EN
VITORIA-GASTEIZ (ESPAÑA)**
100% DESIGNED AND
MANUFACTURED IN
VITORIA-GASTEIZ (SPAIN)

A PUERTA Y CUERPO
DOOR AND BOX

Sencillo y atractivo buzón con una amplia gama de acabados.

Simple and attractive mailbox with a wide range of finishes.

PERSONALIZACIÓN / CUSTOMIZATION



MÍNIMO/MINIMUM: 20 uds.

REF. JOMACOLOR: 03199

DIMENSIONES / DIMENSIONS

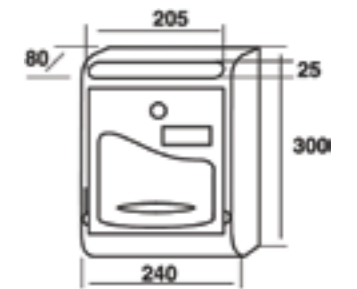

REPUESTOS / SPARE PARTS

TARJETERO / NAMEPLATE: REF. 03070TAR
CERRADURA / LOCK: REF. 51019

 REF. 03181 ● Todo Blanco / All in White EAN: 8413612031812	 REF. 03143 ● Todo Negro / All in Black EAN: 8413612031430	 REF. 03102 ● Negro-Raíz / Black-Root EAN: 8413612031027
 REF. 03109 ● Negro-Pintura INOX Black-INOX paint EAN: 8413612031096	 REF. 03119 ● Todo Pintura INOX All INOX paint EAN: 8413612031195	 REF. 03135 ● Todo Bronce Meteorite All in Meteor Bronze EAN: 8413612031355
 REF. 03103 ● Negro-Mármol Black-Marble EAN: 8413612031034	 REF. 03104 ● Negro-INOX brillo AISI 430 Black-S. Steel Gloss AISI 430 EAN: 8413612031041	



COLUMN V270



JOMA QUALITY GUARANTEE
MADE IN SPAIN

100% DISEÑO Y FABRICADO EN VITORIA-GASTEIZ (ESPAÑA)
100% DESIGNED AND MANUFACTURED IN VITORIA-GASTEIZ (SPAIN)



PUERTA Y CUERPO
DOOR AND BOX

Perfecta relación calidad precio. Robusto y práctico.

Best value for money. Solid, strong and practical.

PERSONALIZACIÓN / CUSTOMIZATION



MÍNIMO/MINIMUM: 20 uds.

REF. JOMACOLOR: 08425

DIMENSIONES / DIMENSIONS

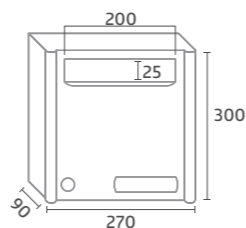

REPUESTOS / SPARE PARTS

TARJETERO / NAMEPLATE: REF. 03070TAR
CERRADURA / LOCK: REF. 51020CL



Ref. 08412 ●
Todo Pintura INOX
All in INOX paint
EAN: 8413612084122

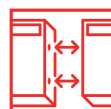

Opción de unión lateral. Dispone de agujeros.
Lateral union option. Holes available for lateral fixing.



Ref. 08001 ●
Todo Blanco
All in White
EAN: 8413612080018



Ref. 08409 ●
Todo Negro
All in Black
EAN: 8413612084092



Ref. 08405 ●
Negro-INOX Brillo AISI 430
Black-S. Steel Gloss AISI 430
EAN: 8413612084054



Ref. 08016 ●
Negro-Raíz
Black-Root
EAN: 8413612080162



Ref. 08014 ●
Negro-Mongoi
Black-Mongoi wood
EAN: 8413612080148



Ref. 08017 ●
Negro-Mármol
Black-Marble
EAN: 8413612080179

EVO 10



REF. 24858 ●
Negro / Black
EAN: 8413612248586



REF. 24857 ●
Blanco / White
EAN: 8413612248579



REF. 24856 ●
Negro-INOX Mate AISI 304
Black-S. Steel Matt AISI 304
EAN: 8413612248562



PUERTA Y CUERPO
DOOR AND BOX

Buzón versátil para uso individual o comunidad, líneas rectas, diseño contemporáneo.

New mailbox, for both Individual use and multiple mailbox option, straight lines, contemporary design.

DIMENSIONES / DIMENSIONS

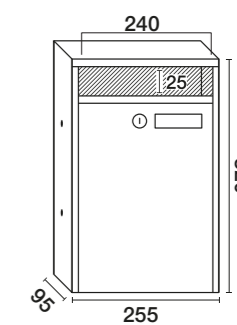

REF. 24859 ●
Plata / Silver
EAN: 8413612248593



Opción de unión lateral. Dispone de agujeros.
Lateral union option. Holes available for lateral fixing.



IRIS 500



Ref. 80137 ●
 Todo Pintura INOX
 All in INOX paint
 EAN: 8413612801378

Ref. 80139 ●
 Todo Bronce Meteorite
 All in Meteor Bronze
 EAN: 8413612801392



PERSONALIZABLE! CUSTOMIZABLE!

Frontal compuesto por tapa de metacrilato sobre chapa de color personalizable.

Front methacrylate sheet for customized color or design.

JOMA
 QUALITY
 GUARANTEE
 MADE IN
 SPAIN

100% DISEÑO
 Y FABRICADO EN
 VITORIA-GASTEIZ (ESPAÑA)
 100% DESIGNED AND
 MANUFACTURED IN
 VITORIA-GASTEIZ (SPAIN)

AE CUERPO
 BOX

ALU PUERTA
 DOOR

**Antivandálico: Puerta de aluminio
 inyectado de 3 mm de espesor.**

Anti-theft: Cast Aluminium
 door 3 mm.

PROPIEDADES / PROPERTIES

ANTIVANDÁLICO
 ANTI-THEFT

PERSONALIZACIÓN / CUSTOMIZATION

JomaColor P. 94

MÍNIMO/MINIMUM: 10 uds.

REF. JOMACOLOR: 24583

DIMENSIONES / DIMENSIONS

EAN 13724

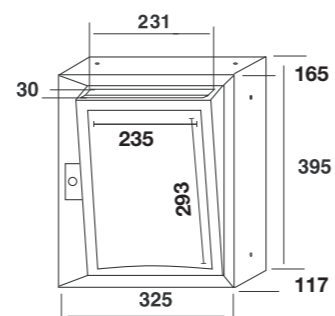

REPUESTOS / SPARE PARTS

CERRADURA / LOCK: REF. 51033

VERTIK RC



REF. 24863 ●
 Negro / Black
 EAN: 8413612248630



REF. 24862 ●
 Blanco / White
 EAN: 8413612248623



REF. 24865 ●
 Verde Foresta / Forest Green
 EAN: 8413612248654



REF. 24864 ●
 Plata / Silver
 EAN: 8413612248647

A PUERTA Y CUERPO
 DOOR AND BOX

**Buzón versátil con triple función:
 buzón individual, agrupable (en
 destino) y recogecartas.**

Versatile mailbox with triple function:
 individual mailbox, banked (in
 destination) and rear retrieval.

DIMENSIONES / DIMENSIONS

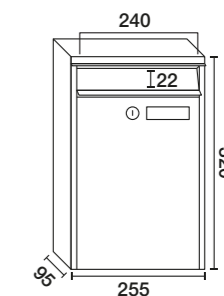

BOCA TRASERA / REAR RETRIEVAL
 220 x 30

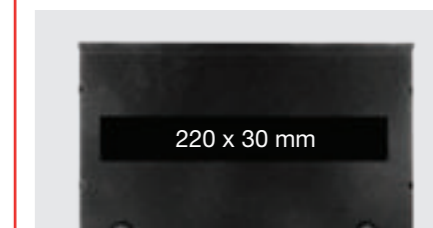

Doble función recogecartas.
 Dual function, two ways letterbox.



SEKKEI



REF. 09680 ●

Negro / Black

EAN: 8413612096804



CUERPO
BOX



FRANJA PUERTA
DOOR STRIPE

Buzón estrecho vertical de diseño sofisticado y válido para cualquier tipo de residencia. El asa de acero inoxidable Mate AISI 304, lo convierte en un aspecto destacado en la entrada de cualquier vivienda.

Narrow vertical mailbox of sophisticated design and valid for any type of residence. The Stainless Steel handle AISI 304 Matt, makes it a highlight at the entrance of any home.

PROPIEDADES / PROPERTIES



GRAN ESTANQUEIDAD
WATERTIGHT

DIMENSIONES / DIMENSIONS

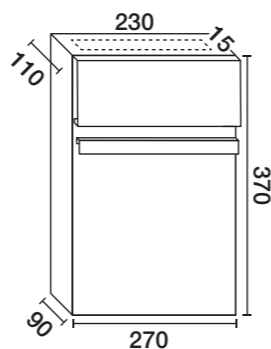

AIR PLUS



REF. 24866 ●

INOX Mate AISI 304
Stainless Steel Matt AISI 304

EAN: 8413612248661

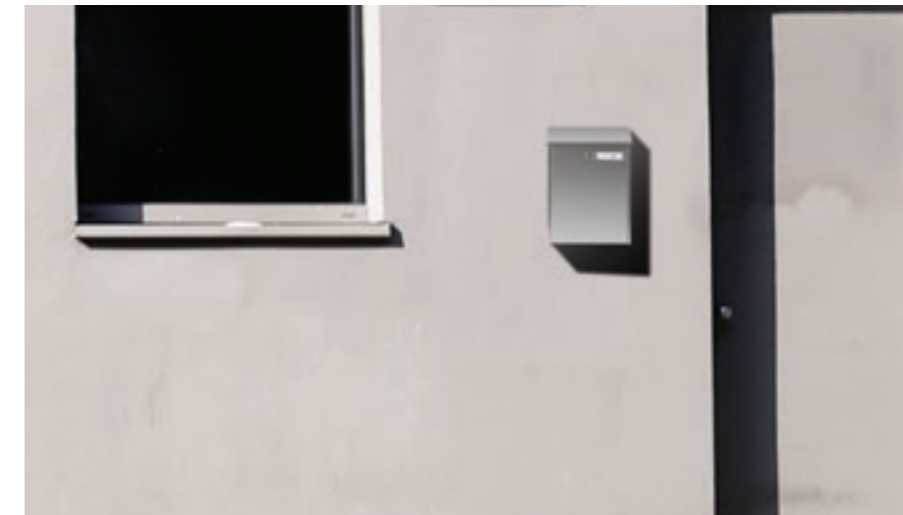

CUERPO Y PUERTA
BOX AND DOOR

Buzón vertical de exterior Inoxidable AISI 304. Dispone de un tejado abatible, gran capacidad y seguridad antipesca. Ideal para dar un toque de elegancia a su entrada.

Vertical individual mailbox for external use, made in AISI 304 stainless Steel. It has a folding roof, great capacity and anti-fishing. Ideal to give a touch of elegance to your entrance.

PROPIEDADES / PROPERTIES



GRAN ESTANQUEIDAD
WATERTIGHT

DIMENSIONES / DIMENSIONS

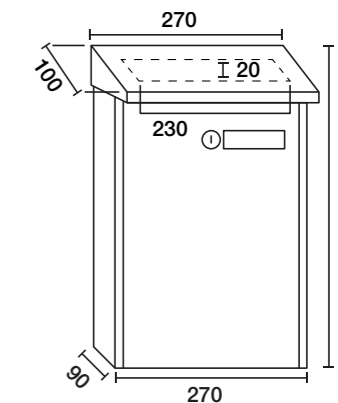

KOMPACT VE36



REF. 24628 ●
 Pintura INOX (Marine)
 INOX paint (Marine)
 EAN: 8413612246285

REF. 24629 ●
 Gris Forja (Marine) /
 Forging Grey (Marine)
 EAN: 8413612246292



Cerradura Serie Plus.
 Anticorrosión.
 New Plus lock. Anti-rust.



ACABADO MARINE INTEGRADO
 INTEGRATED MARINE FINISH

+ Compatible son soporte.
 Compatible with support.

SOPORTE/SUPPORT
KOMPACT VE36
 ø 50 / h= 1000 mm
REF. 24729
 EAN: 8413612247299

PLACA FIJACIÓN SUELO
 PLATE FIXING FLOOR
REF. 24698
 EAN: 8413612246988



JOMA
 QUALITY
 GUARANTEE
**MADE IN
 SPAIN**

**100% DISEÑADO
 Y FABRICADO EN
 VITORIA-GASTEIZ (ESPAÑA)**
 100% DESIGNED AND
 MANUFACTURED IN
 VITORIA-GASTEIZ (SPAIN)

AE PUERTA Y CUERPO
 DOOR AND BOX

AE PUERTA Y CUERPO
 DOOR AND BOX

**Buzon Premium para zonas de alta
 corrosión salina, ya que incorpora
 el acabado Marine con una doble
 protección con envolvente.**

Premium Mailbox for corrosive sea front
 coastal areas, which incorporates both
 MARINE finish and a surround for double
 protection.

PROPIEDADES / PROPERTIES

GRAN ESTANQUEIDAD
 WATERTIGHT

ANTIVANDÁLICO
 ANTI-THEFT

PERSONALIZACIÓN / CUSTOMIZATION

JomaColor P. 94

MÍNIMO/MINIMUM: 10 uds.

REF. JOMACOLOR: 24639

DIMENSIONES / DIMENSIONS

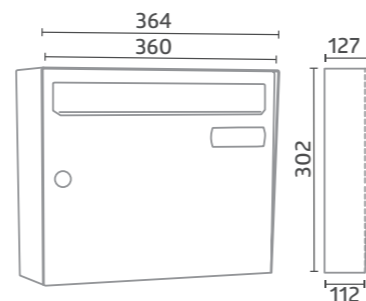

REPUESTOS / SPARE PARTS

TARJETERO / NAMEPLATE: REF. 52005
CERRADURA / LOCK: REF. 51034P

KOMPACT VE27



REF. 24635 ●
 Gris Forja (Marine) /
 Forging Grey (Marine)
 EAN: 8413612246353

REF. 24634 ●
 Pintura INOX (Marine)
 INOX paint (Marine)
 EAN: 8413612246346



Cerradura Serie Plus.
 Anticorrosión.
 New Plus lock. Anti-rust.



ACABADO MARINE INTEGRADO
 INTEGRATED MARINE FINISH

+ Compatible son soporte.
 Compatible with support.

SOPORTE/SUPPORT
KOMPACT VE27
 ø 50 / h= 1000 mm
REF. 24730
 EAN: 8413612247305

PLACA FIJACIÓN SUELO
 PLATE FIXING FLOOR
REF. 24698
 EAN: 8413612246988



Ejemplo buzón y soporte
 personalizado en color
 Óxido Mexican.
 Example of personalized
 mailbox and support in
 Mexican Oxide color.

JOMA
 QUALITY
 GUARANTEE
**MADE IN
 SPAIN**

**100% DISEÑADO
 Y FABRICADO EN
 VITORIA-GASTEIZ (ESPAÑA)**
 100% DESIGNED AND
 MANUFACTURED IN
 VITORIA-GASTEIZ (SPAIN)

AE PUERTA Y CUERPO
 DOOR AND BOX

AE PUERTA Y CUERPO
 DOOR AND BOX

**Buzon Premium para zonas de alta
 corrosión salina, ya que incorpora
 el acabado Marine con una doble
 protección con envolvente.**

Premium Mailbox for corrosive sea front
 coastal areas, which incorporates both
 MARINE finish and a surround for double
 protection.

PROPIEDADES / PROPERTIES

GRAN ESTANQUEIDAD
 WATERTIGHT

ANTIVANDÁLICO
 ANTI-THEFT

PERSONALIZACIÓN / CUSTOMIZATION

JomaColor P. 94

MÍNIMO/MINIMUM: 10 uds.

REF. JOMACOLOR: 24633

DIMENSIONES / DIMENSIONS

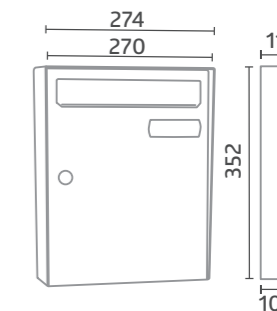

REPUESTOS / SPARE PARTS

TARJETERO / NAMEPLATE: REF. 52005
CERRADURA / LOCK: REF. 51034P

MAGNUM



NEW



REF. 28880 ●
Pintura INOX / INOX paint
EAN: 8413612288704



Gran capacidad

Apertura especial para paquetes,
boca de 275 x 45 mm.
Special for parcel reception
275 x 45 mm flap.



JOMA
QUALITY
GUARANTEE
MADE IN
SPAIN

100% DISEÑO
Y FABRICADO EN
VITORIA-GASTEIZ (ESPAÑA)
100% DESIGNED AND
MANUFACTURED IN
VITORIA-GASTEIZ (SPAIN)

AE

PUERTA Y CUERPO
DOOR AND BOX

ALU

TEJADO
ROOF

Robusto, gran capacidad y diseño de líneas rectas en el cuerpo y curvas en el tejado de aluminio.

Strong, big capacity and straight lines for the body combined with curves in the aluminium roof.

PROPIEDADES / PROPERTIES



GRAN ESTANQUEIDAD
WATERTIGHT



ANTIVANDÁLICO
ANTI-THEFT

PERSONALIZACIÓN / CUSTOMIZATION



P. 94

MÍNIMO/MINIMUM: 10 uds.

REF. JOMACOLOR: 28881

DIMENSIONES / DIMENSIONS

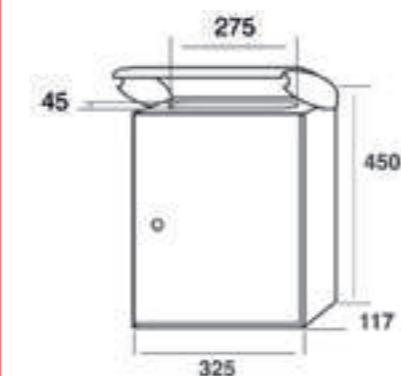

REPUESTOS / SPARE PARTS

TARJETERO / NAMEPLATE: REF. 52005
CERRADURA / LOCK: REF. 51034CL

IRIS 1000



REF. 80168 ●
Bronce Meteorite / Meteor Bronze
EAN: 8413612801682



REF. 80166 ●
Pintura INOX / INOX paint
EAN: 8413612801668



¡Personalizable!

Frontal compuesto por tapa de metacrilato personalizable.

*Láminas no incluidas.

Customizable!

Front composed by methacrylate cover over customizable colour steel. *Prints not included



JOMA
QUALITY
GUARANTEE
MADE IN
SPAIN

100% DISEÑO
Y FABRICADO EN
VITORIA-GASTEIZ (ESPAÑA)
100% DESIGNED AND
MANUFACTURED IN
VITORIA-GASTEIZ (SPAIN)

AE

CUERPO
BOX

ALU

PUERTA Y TEJADO
DOOR AND ROOF

Antivandálico: Puerta de aluminio inyectado de 3 mm de espesor.

Anti-theft: Cast Aluminium door 3 mm.

PROPIEDADES / PROPERTIES



ANTIVANDÁLICO
ANTI-THEFT



GRAN ESTANQUEIDAD
WATERTIGHT

PERSONALIZACIÓN / CUSTOMIZATION



P. 94

MÍNIMO/MINIMUM: 10 uds.

REF. JOMACOLOR: 24680

DIMENSIONES / DIMENSIONS

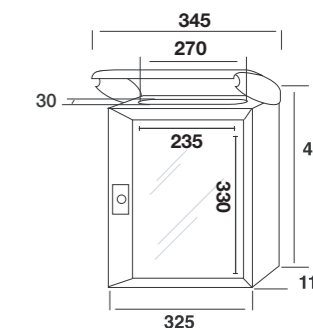

REPUESTOS / SPARE PARTS

CERRADURA / LOCK: REF. 51033

GARDEN 80



REF. 80040 ●
Blanco / White
EAN: 8413612800401



PUERTA Y CUERPO
DOOR AND BOX

Diseñado para armonizar con entornos elegantes y rústicos.

Designed for rustical environments.

DIMENSIONES / DIMENSIONS

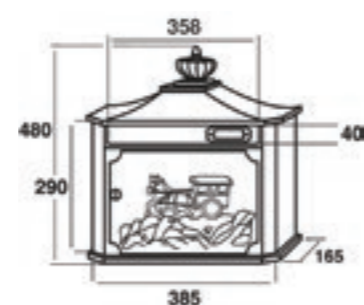

GARDEN 52



BEST SELLER

REF. 09040 ●
Negro
Black
EAN: 8413612090406

REF. 09035 ●
Pintura INOX
INOX paint
EAN: 8413612090352



100% DISEÑADO Y FABRICADO EN VITORIA-GASTEIZ (ESPAÑA)
100% DESIGNED AND MANUFACTURED IN VITORIA-GASTEIZ (SPAIN)



PUERTA Y CUERPO
DOOR AND BOX

El buzón de exterior más emblemático de Joma, presentado en su versión más pequeña, de mediana capacidad y robusta puerta de 1,2 mm.

The archetypal individual mailbox more known from Joma, presented in its smaller version, medium capacity and strong 1.2 mm door.

PROPIEDADES / PROPERTIES



PERSONALIZACIÓN / CUSTOMIZATION



MÍNIMO/MINIMUM: 15 uds.

REF. JOMACOLOR: 24677

DIMENSIONES / DIMENSIONS

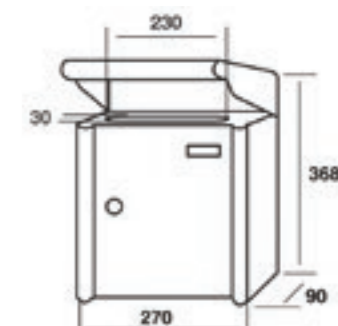

REPUESTOS / SPARE PARTS

TARJETERO / NAMEPLATE: REF. 52005
CERRADURA / LOCK: REF. 51020CL



GARDEN 53



REF. 09507 ●
 Todo Pintura INOX
 All INOX paint
 EAN: 8413612095074

REF. 09060 ●
 Negro
 Black
 EAN: 8413612090604



**100% DISEÑADO
 Y FABRICADO EN
 VITORIA-GASTEIZ (ESPAÑA)**
 100% DESIGNED AND
 MANUFACTURED IN
 VITORIA-GASTEIZ (SPAIN)



PUERTA Y CUERPO
 DOOR AND BOX

El buzón de exterior más emblemático de Joma, presentado en su versión mas vertical, de gran capacidad y robusta puerta de 1,2 mm.

The archetypal individual mailbox more known from Joma, presented in its more vertical version, big capacity and strong 1.2 mm door.

PROPIEDADES / PROPERTIES



GRAN ESTANQUEIDAD
 WATERTIGHT



ANTIVANDÁLICO
 ANTI-THEFT

PERSONALIZACIÓN / CUSTOMIZATION

JomaColor P. 94

MÍNIMO/MINIMUM: 15 uds.

REF. JOMACOLOR: 24678

DIMENSIONES / DIMENSIONS

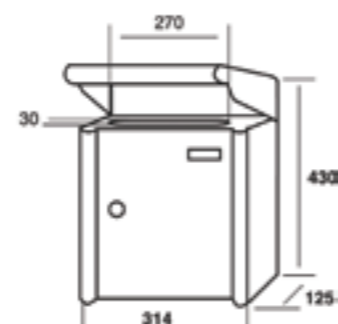

REPUESTOS / SPARE PARTS

TARJETERO / NAMEPLATE: REF. 52005
 CERRADURA / LOCK: REF. 51020CL



GARDEN 54



REF. 09070 ●
 Negro
 Black
 EAN: 8413612090703



REF. 09517 ●
 Pintura INOX
 INOX paint
 EAN: 8413612095173



**100% DISEÑADO
 Y FABRICADO EN
 VITORIA-GASTEIZ (ESPAÑA)**
 100% DESIGNED AND
 MANUFACTURED IN
 VITORIA-GASTEIZ (SPAIN)



PUERTA Y CUERPO
 DOOR AND BOX

El buzón de exterior más emblemático de Joma, presentado en su versión mas horizontal, de gran capacidad y robusta puerta de 1,2 mm.

The archetypal individual mailbox more known from Joma, presented in its more horizontal version, big capacity and strong 1.2 mm door.

PROPIEDADES / PROPERTIES



GRAN ESTANQUEIDAD
 WATERTIGHT



ANTIVANDÁLICO
 ANTI-THEFT

PERSONALIZACIÓN / CUSTOMIZATION

JomaColor P. 94

MÍNIMO/MINIMUM: 15 uds.

REF. JOMACOLOR: 24679

DIMENSIONES / DIMENSIONS



REPUESTOS / SPARE PARTS

TARJETERO / NAMEPLATE: REF. 52005
 CERRADURA / LOCK: REF. 51020CL



GARDEN 05



REF. 09640 ●
INOX Mate AISI 304
Stainless Steel Matt AISI 304
EAN: 8413612096408



REF. 09632 ●
Verde Foresta / Forest Green
EAN: 8413612096323

REF. 09631 ●
Negro / Black
EAN: 8413612096316

REF. 09630 ●
Blanco / White
EAN: 8413612096309



PUERTA Y CUERPO
DOOR AND BOX



PUERTA Y CUERPO
DOOR AND BOX **REF. 09640**

Buzón de gran capacidad y diseño especial con un precio muy competitivo.

Big capacity mailbox with special 2 lines design and a very competitive price.

PROPIEDADES / PROPERTIES



GRAN ESTANQUEIDAD
WATERTIGHT

DIMENSIONES / DIMENSIONS

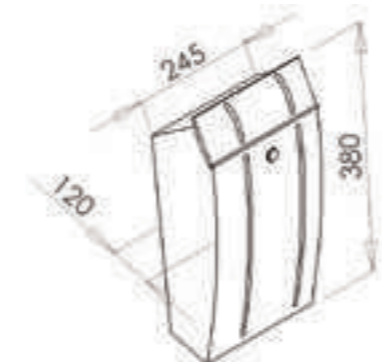

ANCHO DE BOCA / FLAP WIDTH:
240 x 30 mm

AIR RC



REF. 24868 ●
Negro / Black
EAN: 8413612248685



REF. 24867 ●
Blanco / White
EAN: 8413612248678



REF. 24870 ●
Verde Foresta / Forest Green
EAN: 8413612248708



REF. 24869 ●
Plata / Silver
EAN: 8413612248692



Doble función recogcartas
Dual function, two ways letterbox.



PUERTA Y CUERPO
DOOR AND BOX

Perfecta relación entre medidas y capacidad, pudiéndose instalar en lugares de reducido espacio, manteniendo una capacidad Din A4 y con tejado para una mayor protección.

Perfect relationship between dimensions and capacity, recommended for installations in places of limited space, maintaining a Din A4 capacity and with a roof for higher protection.

PROPIEDADES / PROPERTIES



GRAN ESTANQUEIDAD
WATERTIGHT

DIMENSIONES / DIMENSIONS

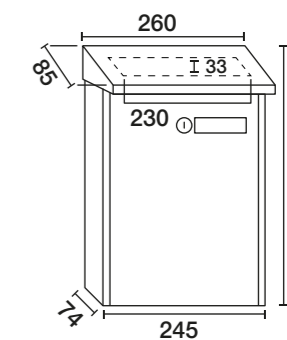

EDEN



REF. 09625 ●

Blanco
White

EAN: 8413612096255



REF. 09626 ●

Negro
Black

EAN: 8413612096262



REF. 09627 ●

Verde Foresta
Forest Green

EAN: 8413612096279



REF. 09628 ●

Plata
Silver

EAN: 8413612096286



PUERTA Y CUERPO
DOOR AND BOX

Buzón vertical de exterior de diseño tradicional, versátil e inmejorable calidad/precio para entornos clásicos.

Vertical individual mailbox for external use, with traditional design e vertical design and best relation between quality and price for classical houses.

DIMENSIONES / DIMENSIONS

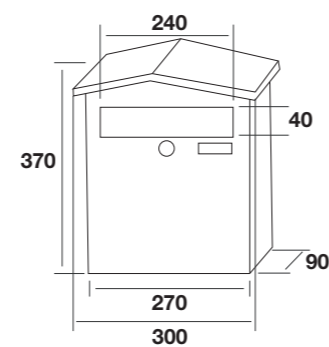

GARDEN 01



REF. 09600 ●

Plata / Silver

EAN: 8413612096002

REF. 09601 ●

Gris Antracita / Anthracite Grey

EAN: 8413612096019



PUERTA Y CUERPO
DOOR AND BOX

Buzón compacto de líneas curvas convexas.

Compact mailbox with convex design curves.

DIMENSIONES / DIMENSIONS

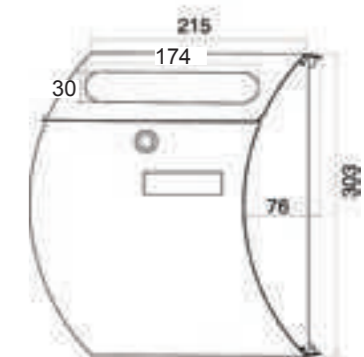

REPUESTOS / SPARE PARTS

TARJETERO / NAMEPLATE: REF. 09600TAR
CERRADURA / LOCK: REF. 51077



GARDEN 50



REF. 09300 ●
Blanco / White
EAN: 8413612093001



REF. 09330 ●
Negro
Black
EAN: 8413612093308



Ref. 09304 ●
Pintura INOX
INOX paint
EAN: 8413612093049



Ejemplo de instalación con Kit Verja.

Installation example with fence kit

P. 46

JOMA
QUALITY
GUARANTEE
MADE IN
SPAIN

100% DISEÑO
Y FABRICADO EN
VITORIA-GASTEIZ (ESPAÑA)
100% DESIGNED AND
MANUFACTURED IN
VITORIA-GASTEIZ (SPAIN)



PUERTA Y CUERPO
DOOR AND BOX

Buzón individual con diseño de tejado tradicional.

Individual mailbox, with traditional roof design.

PROPIEDADES / PROPERTIES



GRAN ESTANQUEIDAD
WATERTIGHT

PERSONALIZACIÓN / CUSTOMIZATION



MÍNIMO/MINIMUM: 20 uds.

REF. JOMACOLOR: 24675

DIMENSIONES / DIMENSIONS

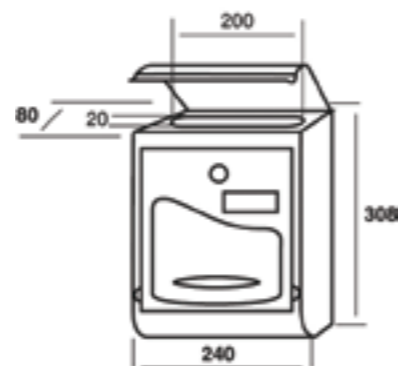

REPUESTOS / SPARE PARTS

TARJETERO / NAMEPLATE: REF. 03070TAR
CERRADURA / LOCK: REF. 51019

GARDEN 51E



REF. 09022 ●
Negro
Black
EAN: 8413612090222



REF. 09029 ●
Pintura INOX
INOX paint
EAN: 8413612090291

JOMA
QUALITY
GUARANTEE
MADE IN
SPAIN

100% DISEÑO
Y FABRICADO EN
VITORIA-GASTEIZ (ESPAÑA)
100% DESIGNED AND
MANUFACTURED IN
VITORIA-GASTEIZ (SPAIN)



PUERTA Y CUERPO
DOOR AND BOX

Buzón de diseño tradicional para ambientes clásicos.

Traditional design mailbox for classical houses.

PROPIEDADES / PROPERTIES



ANTIVANDÁLICO
ANTI-THEFT

PERSONALIZACIÓN / CUSTOMIZATION



MÍNIMO/MINIMUM: 20 uds.

REF. JOMACOLOR: 24676

DIMENSIONES / DIMENSIONS

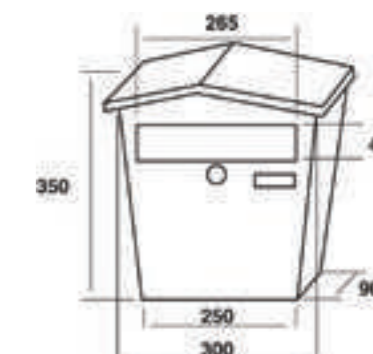

REPUESTOS / SPARE PARTS

TARJETERO / NAMEPLATE: REF. 03070TAR
CERRADURA / LOCK: REF. 51012



GARDEN 70



REF. 80010 ●
Plástico Blanco / White Plastic
EAN: 8413612800104



REF. 80030 ●
Plástico Negro / Black Plastic
EAN: 8413612800302



REF. 80020 ●
Plástico Verde / Green Plastic
EAN: 8413612800203



JOMA
QUALITY
GUARANTEE
MADE IN
SPAIN

100% DISEÑO
Y FABRICADO EN
VITORIA-GASTEIZ (ESPAÑA)
100% DESIGNED AND
MANUFACTURED IN
VITORIA-GASTEIZ (SPAIN)

ABS

PUERTA Y CUERPO
DOOR AND BOX

Buzón individual en plástico de alta resistencia con un diseño conservador y tamaño óptimo.

Individual mailbox of high resistant plastic with a conservative design and optimal size.

PROPIEDADES / PROPERTIES



ANTIVANDÁLICO
ANTI-THEFT



GRAN ESTANQUEIDAD
WATERTIGHT

DIMENSIONES / DIMENSIONS

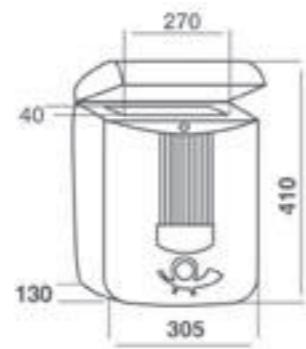

REPUESTOS / SPARE PARTS

TARJETERO / NAMEPLATE: REF. 80010TAR
CERRADURA / LOCK: REF. 51028

Doble función recogecartas.

Dual function, two ways letterbox.



ARCO



REF. 80002 ●
Plástico Negro / Black Plastic
EAN: 8413612800029



REF. 80000 ●
Plástico Verde
Green Plastic
EAN: 8413612800005



REF. 80003 ●
Plástico Burdeos
Bordeaux Plastic
EAN: 8413612800036



REF. 80001 ●
Plástico Blanco
White Plastic
EAN: 8413612800012



JOMA
QUALITY
GUARANTEE
MADE IN
SPAIN

100% DISEÑO
Y FABRICADO EN
VITORIA-GASTEIZ (ESPAÑA)
100% DESIGNED AND
MANUFACTURED IN
VITORIA-GASTEIZ (SPAIN)

ABS

PUERTA Y CUERPO
DOOR AND BOX

Buzón individual en plástico de alta resistencia con un diseño vanguardista irresistible.

Individual mailbox of high resistant plastic with an irresistible avant garde design.

PROPIEDADES / PROPERTIES



ANTIVANDÁLICO
ANTI-THEFT



GRAN ESTANQUEIDAD
WATERTIGHT

DIMENSIONES / DIMENSIONS

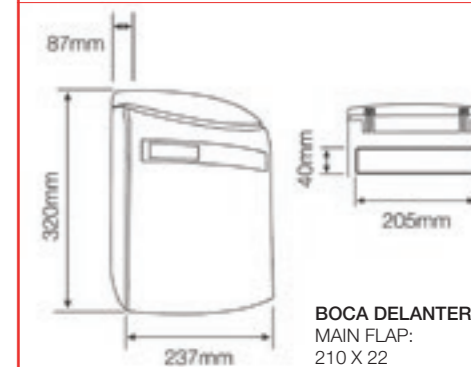

BOCA DELANTERA
MAIN FLAP:
210 X 22

REPUESTOS / SPARE PARTS

TARJETERO / NAMEPLATE: REF. 80000TAR
CERRADURA / LOCK: REF. 51028

Doble función recogecartas.

Dual function, two ways letterbox.



KIT VERJA



KIT VERJA

REF. 24804 ●

EAN: 8413612248043

Composición kit / Kit items:

- 4 Tornillos/Screws M5 x 80
- 4 Tuercas/Nuts M5
- 8 Arandelas/Washers M5
- 2 Soportes/Supports

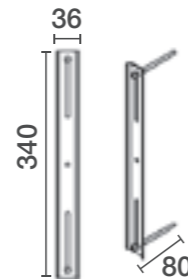

JOMA
QUALITY
GUARANTEE
MADE IN
SPAIN



COMPATIBILIDAD / COMPATIBILITY

TODOS LOS BUZONES Y BUZONES DE PAQUETERÍA JOMA.
ALL JOMA PARCEL BOXES AND INDIVIDUAL MAILBOXES.

RC KOMPACT V270



REF. 08440 ●

Blanco / White

EAN: 8413612084405

REF. 08443 ●

Negro / Black

EAN: 8413612084436

JOMA
QUALITY
GUARANTEE
MADE IN
SPAIN

100% DISEÑADO
Y FABRICADO EN
VITORIA-GASTEIZ (ESPAÑA)
100% DESIGNED AND
MANUFACTURED IN
VITORIA-GASTEIZ (SPAIN)



PUERTA Y CUERPO
DOOR AND BOX

El recogecartas de interior más compacto.

The compact interior mail collector.

PROPIEDADES / PROPERTIES



ANTIVANDÁLICO
ANTI-THEFT

PERSONALIZACIÓN / CUSTOMIZATION

JomaColor

P. 94

MÍNIMO/MINIMUM: 10 uds.

REF. JOMACOLOR: 08444

DIMENSIONES / DIMENSIONS

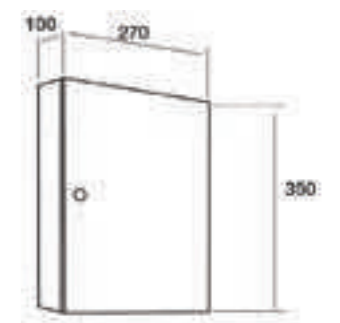

BOCA TRASERA / REAR RETRIEVAL:
250 x 50 mm

REPUESTOS / SPARE PARTS

TARJETERO / NAMEPLATE: REF. 03070TAR
CERRADURA / LOCK: REF. 51034CL



Combínalo con uno de
nuestros bocacartas.

Combine it with one of
our letterplates.

P. 52



RC HALL 10



REF. 08434 ●
Negro / Black
EAN: 8413612084344

95REF. 08430 ●
Blanco / White
EAN: 8413612084306



JOMA
QUALITY
GUARANTEE
MADE IN
SPAIN

100% DISEÑO
Y FABRICADO EN
VITORIA-GASTEIZ (ESPAÑA)
100% DESIGNED AND
MANUFACTURED IN
VITORIA-GASTEIZ (SPAIN)



PUERTA Y CUERPO
DOOR AND BOX

PERSONALIZACIÓN / CUSTOMIZATION



MÍNIMO/MINIMUM: 20 uds.

REF. JOMACOLOR: 24699

DIMENSIONES / DIMENSIONS

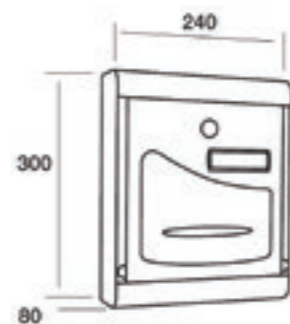

BOCA TRASERA / REAR RETRIEVAL:
215 x 40 mm

REPUESTOS / SPARE PARTS

TARJETERO / NAMEPLATE: REF. 03070TAR
CERRADURA / LOCK: REF. 51019

+ **Combínalo con uno de nuestros bocacartas.**
Combine it with one of our letterplates.

P. 52



RC N1



REF. 08450 ●
Blanco / White
EAN: 8413612084504

REF. 08452 ●
Negro / Black
EAN: 8413612084528

JOMA
QUALITY
GUARANTEE
MADE IN
SPAIN

100% DISEÑO
Y FABRICADO EN
VITORIA-GASTEIZ (ESPAÑA)
100% DESIGNED AND
MANUFACTURED IN
VITORIA-GASTEIZ (SPAIN)



PUERTA Y CUERPO
DOOR AND BOX

Robusto, ¡con refuerzo lateral de gran espesor!

Strong body, with reinforced thicker side.

PERSONALIZACIÓN / CUSTOMIZATION



REF. JOMACOLOR:

RC N1 24701

RC N2 24702

MÍNIMO/MINIMUM: 10 uds.

RC N1 DIMENSIONES / DIMENSIONS

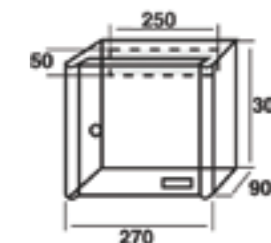

RC N2 DIMENSIONES / DIMENSIONS

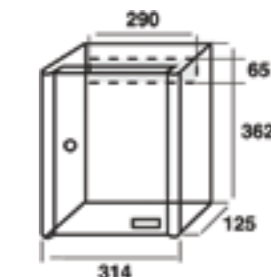

REPUESTOS / SPARE PARTS

TARJETERO / NAMEPLATE: REF. 03070TAR
CERRADURA / LOCK: REF. 51020CL

RC N2



REF. 08464 ●
Negro / Black
EAN: 8413612084641

REF. 08460 ●
Blanco / White
EAN: 8413612084603

+ **Combínalo con uno de nuestros bocacartas.**

Combine it with one of our letterplates.

P. 52

RC EVO 40 PACK

BUZÓN + BOCACARTAS
MAILBOX + LETTERPLATE



BOCACARTAS DESIGN 330 LETTERPLATE

REF. 08491
INOX Mate AISI 304
Stainless Steel Matt AISI 304
EAN: 8413612084917

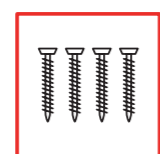

FIJACIONES INCLUIDAS
FIXINGS INCLUDED



AISI 304 MATE
PUERTA Y CUERPO
DOOR AND BOX

Nueva evolución de nuestro recogecartas de exteriores G40 en Inox mate AISI 304, con nuevas dimensiones, entrada de boca y nuevo bocacartas DESIGN 330 en el pack.

Contiene tornillería especial para unir incluso a través de muro.

New evolution of our G40 mailcollector for external use in 304 Matt Stainless Steel finish, with new dimensions, letterslot and DESIGN letterplate 330 included in the pack.

Includes special screws for wall installations.

PROPIEDADES / PROPERTIES



GRAN ESTANQUEIDAD
WATERTIGHT

DIMENSIONES / DIMENSIONS

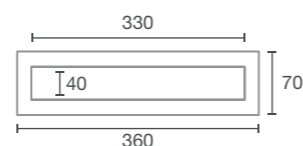
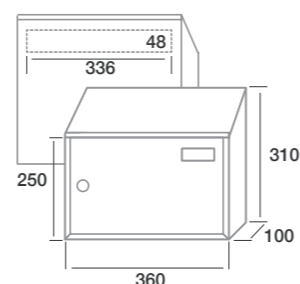

RC EVO 40



REF. 08495
Pintura INOX / INOX paint
EAN: 8413612084955



REF. 08494
Negro / Black
EAN: 8413612084948



REF. 08492
Blanco / White
EAN: 8413612084924



100% DISEÑADO Y FABRICADO EN VITORIA-GASTEIZ (ESPAÑA)
100% DESIGNED AND MANUFACTURED IN VITORIA-GASTEIZ (SPAIN)

Nueva evolución de nuestro recogecartas de exteriores.

New evolution of our G40 mailcollector for external use.



AE
PUERTA Y CUERPO
DOOR AND BOX

PROPIEDADES / PROPERTIES



GRAN ESTANQUEIDAD
WATERTIGHT

PERSONALIZACIÓN / CUSTOMIZATION



MÍNIMO/MINIMUM: 10 uds.

REF. JOMACOLOR: 08496

DIMENSIONES / DIMENSIONS

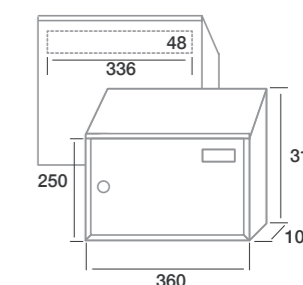

REPUESTOS / SPARE PARTS

TARJETERO / NAMEPLATE: REF. 52005
CERRADURA / LOCK: REF. 51020CL



Combínalo con uno de nuestros bocacartas.

Combine it with one of our letterplates.

P. 52



BOCACARTAS PUSH

PUSH 220



Sistema
← PUSH



REF. 09144 ●
Negro / Black | EAN: 8413612091441



REF. 09145 ●
INOX Mate AISI 304 / Stainless Steel Matt AISI 304
EAN: 8413612091458

COMPATIBILIDAD / COMPATIBILITY

- ✓ GARDEN 70 ✓ RC KOMPACT V 270
- ✓ RC N1 ✓ RC N2 ✓ RC EVO 40

DIMENSIONES / DIMENSIONS

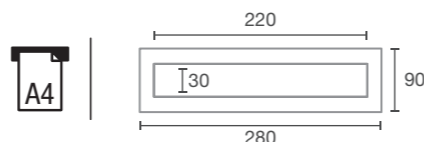

PUSH 310



Sistema
← PUSH



REF. 09140 ●
Negro / Black
EAN: 8413612091403



REF. 09141 ●
INOX Mate AISI 304 / Stainless Steel Matt AISI 304
EAN: 8413612091410

COMPATIBILIDAD / COMPATIBILITY

- ✓ RC EVO 40

DIMENSIONES / DIMENSIONS

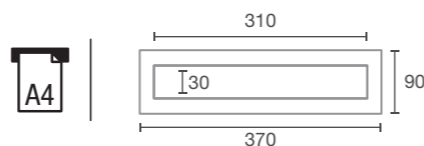

COMPATIBILIDAD / COMPATIBILITY: ✓ ÓPTIMO/OPTIMUM | ✓ COMPATIBLE/COMPATIBLE

BOCACARTAS ESTÁNDAR

ESTÁNDAR 210



REF. 09125 ●
Blanco / White
EAN: 8413612091250



REF. 09127 ●
Negro / Black
EAN: 8413612091274

JOMA
QUALITY
GUARANTEE
MADE IN
SPAIN



COMPATIBILIDAD / COMPATIBILITY

- ✓ VERTIK ✓ AIR RC ✓ ARCO
- ✓ GARDEN 70 RC ✓ HALL 10 RC
- ✓ KOMPACT V270 RC ✓ RC N1
- ✓ RC N2 ✓ RC EVO 40

DIMENSIONES / DIMENSIONS

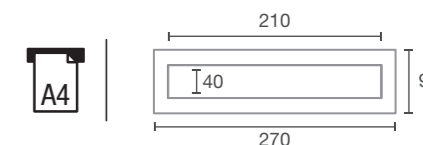

ESTÁNDAR 265



REF. 09110 ●
Blanco / White
EAN: 8413612091106



REF. 09113 ●
Negro / Black
EAN: 8413612091137



REF. 09102 ●
Pintura INOX / INOX paint
EAN: 8413612091021

JOMA
QUALITY
GUARANTEE
MADE IN
SPAIN



COMPATIBILIDAD / COMPATIBILITY

- ✓ RC N2 ✓ RC EVO 40

PERSONALIZACIÓN / CUSTOMIZATION



P. 94

MÍNIMO/MINIMUM: 20 uds.

REF. JOMACOLOR: 24703

DIMENSIONES / DIMENSIONS

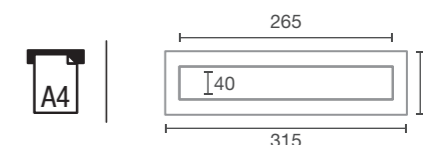

REPUESTOS / SPARE PARTS

TARJETERO / NAMEPLATE: REF. 03070TAR



COMPATIBILIDAD / COMPATIBILITY: ✓ ÓPTIMO/OPTIMUM | ✓ COMPATIBLE/COMPATIBLE

ESTÁNDAR 330



REF. 09130 ●
Blanco / White
EAN: 8413612091304



REF. 09132 ●
Negro / Black
EAN: 8413612091328



REF. 09133 ●
Pintura INOX / INOX paint
EAN: 8413612091335



JOMA
QUALITY
GUARANTEE
MADE IN
SPAIN



COMPATIBILIDAD / COMPATIBILITY

✓ RC EVO 40

PERSONALIZACIÓN / CUSTOMIZATION



MÍNIMO/MINIMUM: 20 uds.

REF. JOMACOLOR: 09134

DIMENSIONES / DIMENSIONS

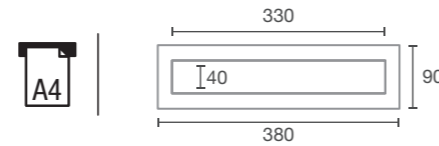

REPUESTOS / SPARE PARTS

TARJETERO / NAMEPLATE: REF. 03070TAR

BOCACARTAS DESIGN 330



REF. 09152 ●
Blanco / White | EAN: 8413612091526

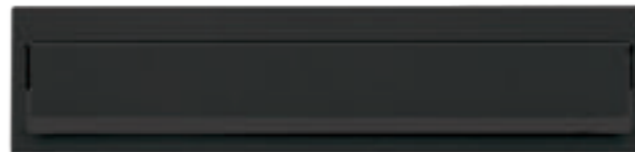

REF. 09155 ●
Negro / Black | EAN: 8413612091557



REF. 09153 ●
Verde Foresta / Forest Green | EAN: 8413612091533



REF. 09156 ●
Pintura INOX / INOX paint | EAN: 8413612091564



COMPATIBILIDAD / COMPATIBILITY

✓ RC EVO 40

DIMENSIONES / DIMENSIONS

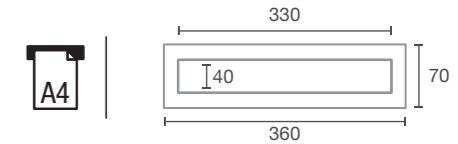

BOCACARTAS INOX 240



REF. 09100 ●
INOX Mate AISI 304 / Stainless Steel Matt AISI 304
EAN: 8413612091007

JOMA
QUALITY
GUARANTEE
MADE IN
SPAIN

COMPATIBILIDAD / COMPATIBILITY

✓ GARDEN 70 RC ✓ KOMPACT V270 RC
✓ RC N1 ✓ RC N1 ✓ RC EVO 40

PERSONALIZACIÓN / CUSTOMIZATION



MÍNIMO/MINIMUM: 20 uds.

REF. JOMACOLOR: 09135

DIMENSIONES / DIMENSIONS

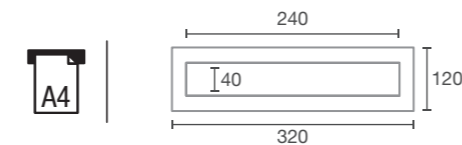

BOCACARTAS INOX 265



REF. 09101 ●
INOX Mate AISI 304 / Stainless Steel Matt AISI 304
EAN: 8413612091014

JOMA
QUALITY
GUARANTEE
MADE IN
SPAIN

COMPATIBILIDAD / COMPATIBILITY

✓ RC N1 ✓ RC N2 ✓ RC EVO 40

PERSONALIZACIÓN / CUSTOMIZATION



MÍNIMO/MINIMUM: 20 uds.

REF. JOMACOLOR: 09136

DIMENSIONES / DIMENSIONS

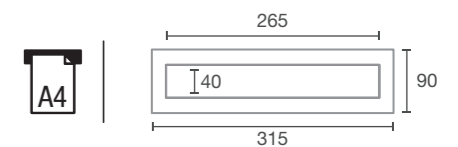



JomaSafe

Soluciones de Seguridad

Security solutions

CAJA LLAVE EMERGENCIA
EMERGENCY KEY BOX

MADE IN SPAIN

PROFESIONAL

CON MAZA / WITH HAMMER



BEST SELLER



Para su comodidad solicite cajas con la misma llave.
For your convenience, request boxes with the same key.

REF. 01038 ●
Con maza / With hammer

NEW REF. 01033
Llaves iguales / Key alike

SIN MAZA / WITHOUT HAMMER



REF. 01039 ●
Sin maza / Without hammer

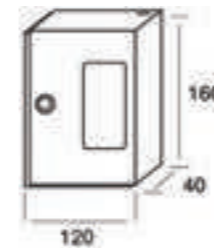

RECAMBIOS
SPARE PARTS

REF. 01040 ●
MAZA / MAZE

REF. 52007 ●
CRISTAL / GLASS
75 x 115 mm

CAJA LLAVE EMERGENCIA PUERTA CIEGA
EMERGENCY KEY BOX BLIND DOOR

MADE IN SPAIN

PROFESIONAL



REF. 01035 ●
Puerta ciega sin maza /
Blind door without hammer



REF. 01028
GAS / GAS



REF. 01019
AGUA / WATER



REF. 01020
ELECTRICIDAD / ELECTRICITY



REF. 01032
TRIANGULAR / TRIANGULAR

NEW



Cerraduras homologadas por Gas Natural, Electricidad, Aguas, etc.

Officially approved locks.

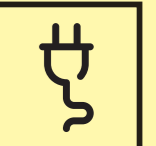

BUZÓN SERVICIO EMERGENCIA
EMERGENCY SERVICE MAILBOX

MADE IN SPAIN



✓ Armario para guardar planos para los servicios de emergencia.

Cabinet for keeping plans for emergency services

Según decreto 102/2000 publicado en el BOPV 2001113 del 14.06.2001 que establece la ordenación de los establecimientos hoteleros de regulación de empresas turísticas y alojamiento turístico.

REF. 03003 ●
Rojo con cristal
Red with glass

REF. 03002CRI ●
Cristal
Glass

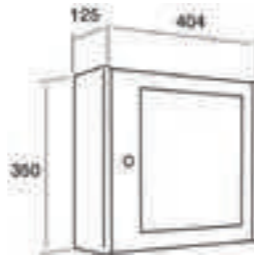

ARMARIO LIBRO DE EDIFICIO
CABINET FOR BUILDING SPECIFICATIONS

MADE IN SPAIN



✓ Armario libro de edificio. Decreto 250/2003 BOPV 25.11.03 Normativa D. 2502/2013

Cabinet for building specifications.



Cerradura con 3 puntos de cierre
3 locking points lock

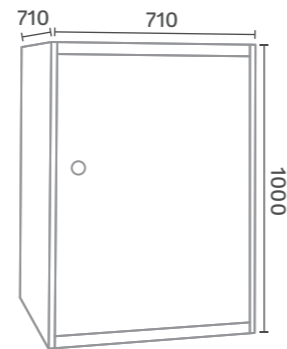

BEST SELLER

REF. 90143 ●
Gris Perla / Pearl Grey

PRO PLUS

INCLUIDO / INCLUDED



GANCHOS NUMERADOS
NUMBERED HOOKS



ÍNDICE NUMERADO
INDEX CARD



LLAVEROS
KEYRINGS



FIJACIONES
FIXINGS

JOMA
QUALITY
GUARANTEE
MADE IN
SPAIN

NEW

Hasta 1200 llaves

4 medidas de armarios,
11 opciones de capacidad.

Up to 1200 keys

4 dimensions of cabinets,
11 capacity options.



250 / 300 llaves/keys



400 / 500 / 600 llaves/keys



700 / 800 / 900 llaves/keys



1000 / 1100 / 1200 llaves/keys

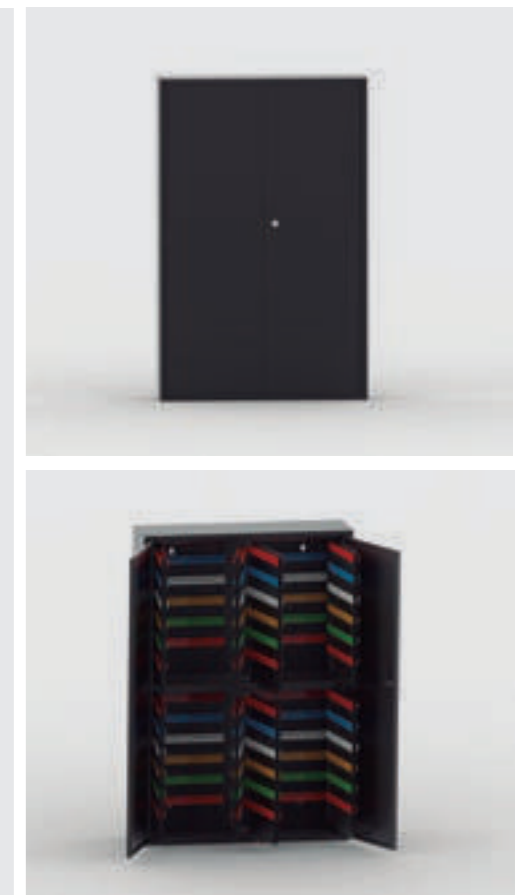

PRO PLUS

MAYOR SEGURIDAD

Cierre de 3 puntos y cerradura Serie Plus de 2000 combinaciones.

Opción de 3 tipos de cerradura



SERIE PLUS COMBI ROUND ELECTRONIC

HIGHER SECURITY

3 closing points and 2000 different combinations with the Serie Plus key lock.

3 optional locks.

FLEXIBLE

El innovador sistema PRO PLUS, permite crecer en capacidad dentro del mismo módulo, simplemente añadiendo nuevos ganchos adicionales.

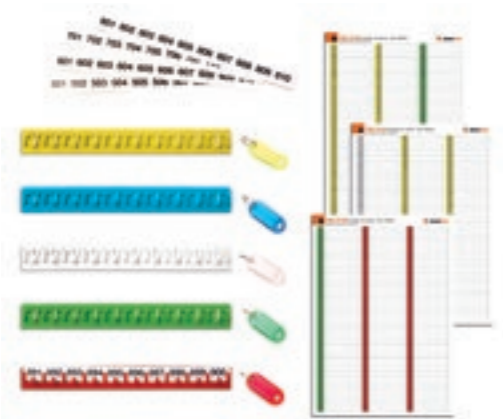

FLEXIBILITY

The innovative PRO PLUS system, allows to grow in capacity into the same cabinet, by simply adding new hooks.

REPUESTOS DISPONIBLES



Posibilidad de reponer ganchos de colores, tiras de numeración y llaveros de colores.

SPARE PARTS AVAILABLE

Possibility to replace colour hooks, strips of numbering and colour plastic keyrings.

SENCILLO

Cada usuario puede personalizar la distribución, combinando los paneles y ganchos de colores. Incluye fichas personalizadas, para el registro y clasificación de las llaves.

EASY & SIMPLE

Each user can customize the key cabinet distribution, just combining the panels and the adjustable colour hooks. We include personalized sheets, for a perfect key classification and registration.

ROBUSTO

Construcción en chapa de acero electrozincado, con un diseño muy robusto. Acabado Premium, en pintura texturada Gris Forja.

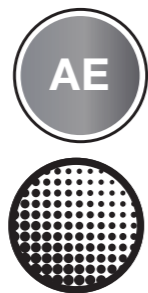

STURDY CONSTRUCTION

Manufactured in electrogalvanized sheet steel, with a very robust design. Premium textured Forging Grey finishing.

OPCIONAL BIFUNCIONAL: SOPORTES DE SEGURIDAD Y MOVILIDAD

Nuevo sistema opcional de 2 soportes de seguridad laterales, permitiendo movilidad para adaptación a múltiples ubicaciones, y dar más seguridad, para los módulos de mayor peso.

OPTIONAL BIFUNCIONAL: SECURITY & MOBILITY LATERAL SUPPORTS

New optional installation system with 2 lateral supports, for higher security on the heaviest cabinets and allowing mobility to adapt to multiple locations.

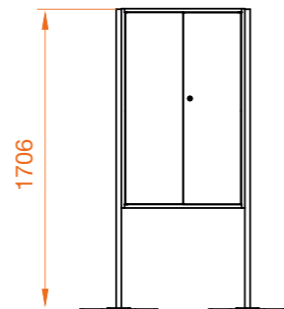

PLACA BASE DE FIJACIÓN A SUELO MÓVIL, CON 2 POSICIONES DE FIJACIÓN.
MOBILE BASE FIXING PLATE, WITH 2 FIXING POSITIONS

CON FIJACIÓN PARED
WHEN FIXED TO THE WALL

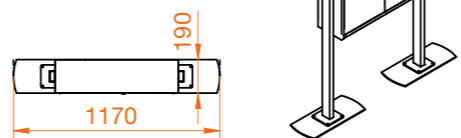

SIN FIJACIÓN PARED
WHEN NOT FIXED TO THE WALL

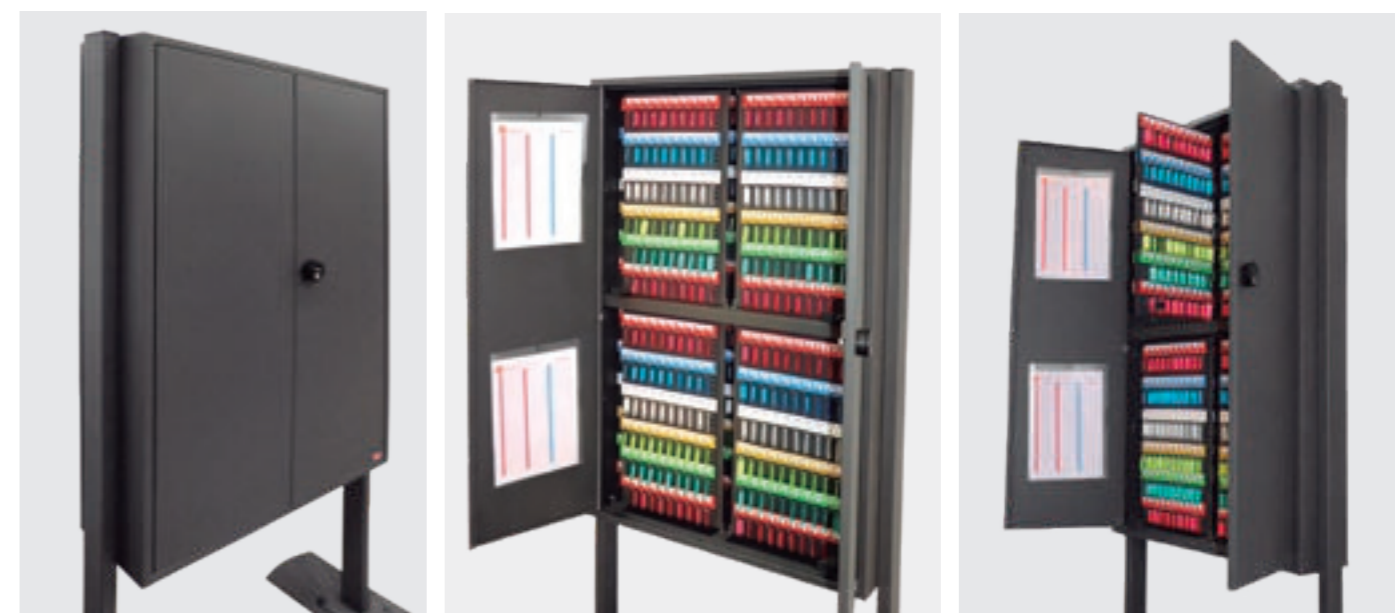
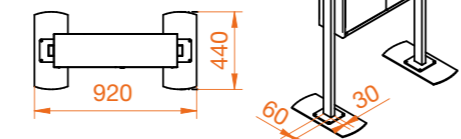

TIPO DE CERRADURA / LOCK TYPE			CAPACIDAD CAPACITY	ANCHO (mm) WIDTH (mm)	ALTO (mm) HEIGHT (mm)	FONDO (mm) DEPTH (mm)	Nº PANELES Nº OF PANELS	Nº CARAS Nº OF SIDES	Nº COLGADORES Nº OF HOOKS
PLUS	COMBI ROUND	ELECTRONIC							
KC0250G ●	KC0250GCR	KC0250GEL	250 ↑	360	580	190	2	5	25
KC0300G ●	KC0300GCR	KC0300GEL	300 ↑						
KC0400G ●	KC0400GCR	KC0400GEL	400 ↑	700	580	190	4	10	40
KC0500G ●	KC0500GCR	KC0500GEL	500 ↑						
KC0600G ●	KC0600GCR	KC0600GEL	600 ↑						
KC0700G ●	KC0700GCR	KC0700GEL	700 ↑	700	800	190	4	10	70
KC0800G ●	KC0800GCR	KC0800GEL	800 ↑						
KC0900G ●	KC0900GCR	KC0900GEL	900 ↑						
KC1000G ●	KC1000GCR	KC1000GEL	1000 ↑	700	1130	190	8	20	100
KC1100G ●	KC1100GCR	KC1100GEL	1100 ↑						
KC1200G ●	KC1200GCR	KC1200GEL	1200 ↑				8	20	120

REPUESTOS GANCHOS / COLOUR HOOKS SPARE PARTS			REPUESTOS CERRADURAS / LOCKS SPARE PARTS		
02098G10B			MK501BCR		COMBI ROUND LOCK
02098G10R			MK501BCR-MK		LLAVE EMERGENCIA COMBI
02098G10Y			EK501BEL		CERRADURA ELECTRÓNICA RAS
02098G10W			EK501BEL-MK		LLAVE EMERGENCIA ELECTRÓNICA
02098G10V					

KC53199		JUEGO DE 2 SOPORTES LATERALES PRO PLUS 2 PRO PLUS LATERAL SUPPORTS SET
---------	--	---

PROFESIONAL

INCLUIDO / INCLUDED



GANCHOS NUMERADOS
NUMBERED HOOKS

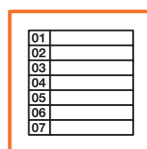

ÍNDICE NUMERADO
INDEX CARD



LLAVEROS
KEYRINGS



FIJACIONES
FIXINGS



JOMA
QUALITY
GUARANTEE
MADE IN
SPAIN

PERSONALIZACIÓN / CUSTOMIZATION



P. 94

MÍNIMO/MINIMUM: 10 uds.

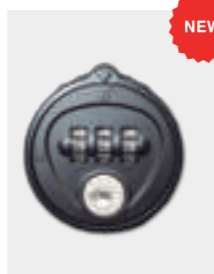

CERRADURA / LOCK
COMBI ROUND



CERRADURA / LOCK
ELECTRÓNICA GEMINIS

**BEST
SELLER**

CAPACIDAD CAPACITY	Nº PANELES Nº OF PANELS	MEDIDAS DIMENSIONS	CERRADURA MECÁNICA MECHANICAL LOCK BEIGE	CERRADURA / LOCK COMBI ROUND BEIGE	CERRADURA / LOCK ELECTRÓNICA GEMINIS BEIGE	JOMACOLOR
68 †	0	300 x 390 x 60	02097 ●	02097CR	02097EL	24614
105 †	0	350 x 475 x 60	02098 ●	02098CR	02098EL	24615
148 †	1	300 x 390 x 120	02148 ●	02148CR	02148EL	24616
203 †	2	350 x 475 x 120	02203 ●	02203CR	02203EL	24617
302 †	2	350 x 490 x 180	02302 ●	02302CR	02302EL	24618
406 †*	2	700 x 475 x 120	02416	02416CR	02416EL	24718
604 †**	2	700 x 490 x 180	02616	02616CR	02616EL	24719

* Se compone de dos armarios de 203 llaves.

* Is composed by 2 cabinets of 203 keys.

** Se compone de dos armarios de 302 llaves.

** Is composed by 2 cabinets of 302 keys.

ESTÁNDAR

INCLUIDO / INCLUDED



GANCHOS NUMERADOS
NUMBERED HOOKS

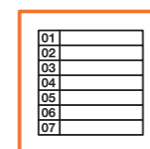

ÍNDICE NUMERADO
INDEX CARD



LLAVEROS
KEYRINGS

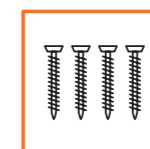

FIJACIONES
FIXINGS



JOMA
QUALITY
GUARANTEE
MADE IN
SPAIN

PERSONALIZACIÓN / CUSTOMIZATION



P. 94

MÍNIMO/MINIMUM: 10 uds.



Gris Forja
Forging grey

Beige
Beige



CAPACIDAD CAPACITY	Nº PANELES Nº OF PANELS	MEDIDAS DIMENSIONS	BEIGE BEIGE	GRIS FORJA FORGING GREY	JOMACOLOR
20 †	0	155 x 200 x 60	02095 ●	24601	24610
30 †	1	155 x 200 x 60	02093 ●	24602	24611
42 †	0	215 x 290 x 60	02096 ●	-	24612
70 †	1	215 x 290 x 60	02094 ●	-	24613

RECAMBIOS ARMARIOS DE LLAVES KEY CABINET SPARE PARTS

02097G08	Recambio colgador individual 8 ganchos / Replacement hook 8
02098G10	Recambio colgador individual 10 ganchos / Replacement hook 10
02097G11	Recambio colgador individual 11 ganchos / Replacement hook 11
02098G13	Recambio colgador individual 13 ganchos / Replacement hook 13
02100BOL	Bolsa de 100 llaveros de plástico colores surtidos / Bag of 100 plastic key tags assorted colors
02095BOL	Bolsa de 20 llaveros de plástico colores surtidos / Bag of 20 plastic key tags assorted colors
52001	Llavero de plástico individual / Single Plastic key tag
51088	Cerradura electronica geminis (incl. Llave emerg.) / Geminis electronic lock (incl. emergency key)

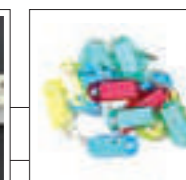
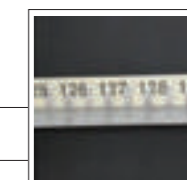

51 LLAVES

INCLUIDO / INCLUDED



ALU

JOMA
QUALITY
GUARANTEE
MADE IN
SPAIN



	Capacidad Capacity	Medidas Exteriores External Dimensions A x B x C (mm)
Ref. 02082	51 †	497 x 364 x 60

BASIC

INCLUIDO / INCLUDED



	Capacidad Capacity	Nº PANELES Nº OF PANELS	Medidas Exteriores External Dimensions A x B x C (mm)
REF. 02192 ●	50 †	0	240 x 300 x 60
REF. 02196 ●	108 †	0	240 x 240 x 75
REF. 02180 ●	160 †	1	280 x 370 x 80



MADERA / WOOD

INCLUIDO / INCLUDED



	Capacidad Capacity	Medidas Exteriores External Dimensions A x B x C (mm)
REF. 02021 ●	20 †	181 x 213 x 70



JOMA VINTAGE MADE IN SPAIN

A

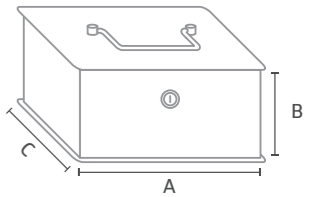
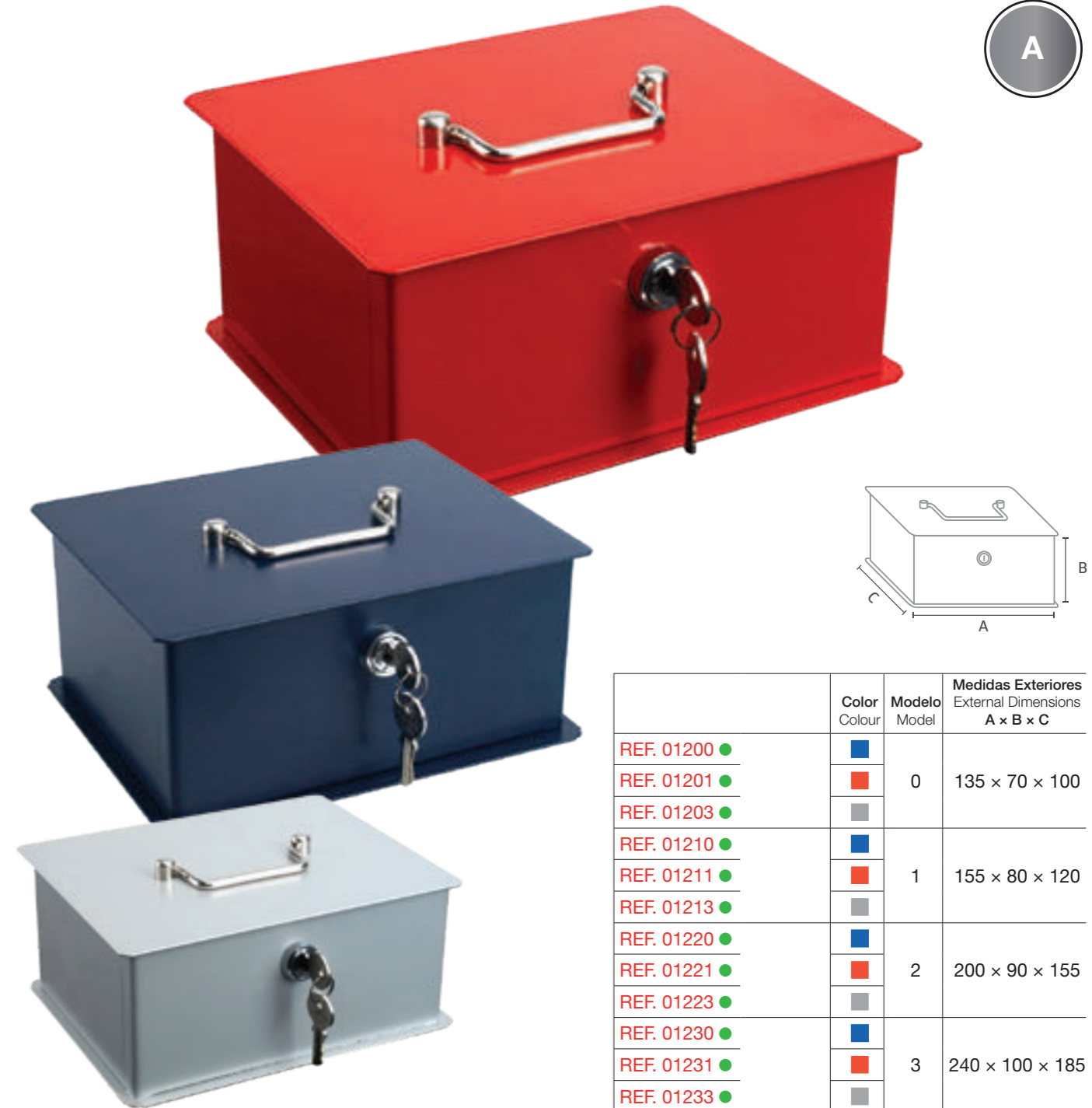

	Color Colour	Modelo Model	Medidas Exteriores External Dimensions A x B x C
REF. 01200 ●	■	0	135 x 70 x 100
REF. 01201 ●	■		
REF. 01203 ●	■		
REF. 01210 ●	■	1	155 x 80 x 120
REF. 01211 ●	■		
REF. 01213 ●	■		
REF. 01220 ●	■	2	200 x 90 x 155
REF. 01221 ●	■		
REF. 01223 ●	■		
REF. 01230 ●	■	3	240 x 100 x 185
REF. 01231 ●	■		
REF. 01233 ●	■		
REF. 01240 ●	■	4	290 x 110 x 215
REF. 01241 ●	■		
REF. 01243 ●	■		
REF. 01250 ●	■	5	350 x 260 x 120
REF. 01251 ●	■		
REF. 01253 ●	■		
REF. 01260 ●	■	6	390 x 300 x 130
REF. 01261 ●	■		
REF. 01263 ●	■		

JOMA VINTAGE HUCHA

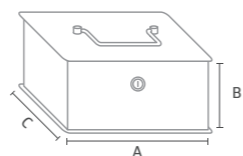

JOMA
QUALITY
GUARANTEE
MADE IN
SPAIN

		Color Colour	Modelo Model	Medidas Dimensions A x B x C (mm)
REF. 01270 ●		■	0H	135 x 70 x 100
REF. 01271 ●		■		
REF. 01280 ●		■	1H	155 x 80 x 120
REF. 01281 ●		■		



Huchas infantiles, pensadas para regalar a los más pequeños.

Saving boxes, a perfect gift for children.

JOMA VINTAGE COMBI HUCHA

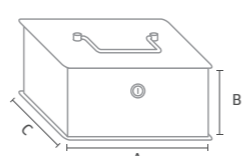

JOMA
QUALITY
GUARANTEE
MADE IN
SPAIN

		Color Colour	Modelo Model	Medidas Exteriores External Dimensions A x B x C (mm)
REF. 06009 ●		■	0H	135 x 70 x 100
REF. 06010 ●		■		
REF. 01273 ●		■		
REF. 06011 ●		■	1H	155 x 80 x 120
REF. 06012 ●		■		



Huchas infantiles, pensadas para regalar a los más pequeños.

Saving boxes, a perfect gift for children.

SUPER JOMA



JOMA
QUALITY
GUARANTEE
MADE IN
SPAIN

**BEST
SELLER**

PERSONALIZACIÓN / CUSTOMIZATION

JomaColor P. 94

MÍNIMO/MINIMUM: 20 uds.



Sin compartimento Without cashier	Con compartimento With cashier	Color Colour	Modelo Model	Medidas Exteriores External Dimensions A x B x C (mm)
01052 ●	01052T ●	■	1	155 x 80 x 120
01062 ●	01062T ●	■		
01302 ●	01302T ●	■		
90315 ●	90315T ●	●		
01053 ●	01053T ●	■	2	200 x 90 x 155
01063 ●	01063T ●	■		
01303 ●	01303T ●	■		
90316 ●	90316T ●	●		
01054 ●	01054T ●	■	3	240 x 100 x 185
01064 ●	01064T ●	■		
01304 ●	01304T ●	■		
90317 ●	90317T ●	●		
01055 ●	01055T ●	■	4	290 x 110 x 215
01065 ●	01065T ●	■		
01305 ●	01305T ●	■		
90318 ●	90318T ●	●		



Compartimento aéreo, para aumentar la capacidad interior de la caja.

Flying cashier, which increases the internal capacity of the cash box.

Si lo necesita, añada un compartimento a su caja Super Joma. You can add our cashiers to your Super Joma cash box.



SUPER JOMA COMBI



JOMA
QUALITY
GUARANTEE
MADE IN
SPAIN

PERSONALIZACIÓN / CUSTOMIZATION



P. 94

MÍNIMO/MINIMUM: 20 uds.

Sin compartimento Without cashier	Con compartimento With cashier	Color Colour	Modelo Model	Medidas Exteriores External Dimensions A x B x C (mm)
06061 ●	06061T ●	■	1	155 x 80 x 120
06071 ●	06071T ●	■		
06041 ●	06041T ●	■		
90319 ●	90319T ●	●	2	200 x 90 x 155
06062 ●	06062T ●	■		
06072 ●	06072T ●	■		
06042 ●	06042T ●	■	3	240 x 100 x 185
90320 ●	90320T ●	●		
06063 ●	06063T ●	■		
06073 ●	06073T ●	■	4	290 x 110 x 215
06043 ●	06043T ●	■		
90321 ●	90321T ●	●		
06064 ●	06064T ●	■	4	290 x 110 x 215
06074 ●	06074T ●	■		
06044 ●	06044T ●	■		
90322 ●	90322T ●	●		

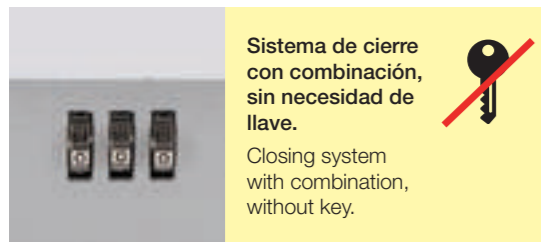

Sistema de cierre con combinación, sin necesidad de llave.



Closing system with combination, without key.

EUROBOX



JOMA
QUALITY
GUARANTEE
MADE IN
SPAIN

PERSONALIZACIÓN / CUSTOMIZATION



P. 94

MÍNIMO/MINIMUM: 20 uds.

Sin compartimento Without cashier	Con compartimento With cashier	Color Colour	Modelo Model	Medidas Exteriores External Dimensions A x B x C (mm)
10065 ●	10065T ●	■	1	160 x 83 x 130
10075 ●	10075T ●	■		
10061 ●	10061T ●	■		
10069 ●	10069T ●	●	2	200 x 93 x 160
10066 ●	10066T ●	■		
10076 ●	10076T ●	■		
10062 ●	10062T ●	■	3	240 x 103 x 190
10070 ●	10070T ●	●		
10067 ●	10067T ●	■		
10077 ●	10077T ●	■	4	330 x 113 x 250
10063 ●	10063T ●	■		
10071 ●	10071T ●	●		
10068 ●	10068T ●	■	4	330 x 113 x 250
10078 ●	10078T ●	■		
10064 ●	10064T ●	■		
10073 ●	10073T ●	●		

+ COMPARTIMENTOS SUPER JOMA CASHIERS

Si lo necesita, añada un compartimento a su caja Super Joma. If you need it, please add our cashiers to your Super Joma cash box.

MODELO 1/MODEL 1



REF. 50001 ●

MODELO 2/MODEL 2



REF. 50002 ●

MODELO 3/MODEL 3



REF. 50003 ●

MODELO 4/MODEL 4



REF. 50004 ●

+ COMPARTIMENTOS EUROBOX CASHIERS

Si lo necesita, añada un compartimento a su caja Eurobox. If you need it, please add our cashiers to your Eurobox cash box.

MODELO 1/MODEL 1



REF. 50051 ●

MODELO 2/MODEL 2



REF. 50052 ●

MODELO 3/MODEL 3



REF. 50053 ●

MODELO 4/MODEL 4



REF. 50054 ●

JOMA 3B



		Color Colour	Modelo Model	Medidas Exteriores External Dimensions A x B x C (mm)
REF. 15015 ●		■	1	152 x 80 x 118
REF. 15012 ●		■		
REF. 15051 ●		■		
REF. 15021 ●		■	2	200 x 90 x 160
REF. 15022 ●		■		
REF. 15052 ●		■		
REF. 15035 ●		■	3	250 x 90 x 180
REF. 15032 ●		■		
REF. 15034 ●		■		

Bandeja incorporada.
With built tray.



JOMA 3B HUCHA



		Color Colour	Modelo Model	Medidas Exteriores External Dimensions A x B x C (mm)
REF. 15001 ●		■	1	152 x 80 x 118
REF. 15005 ●		■		



JOMA EURO 1



JOMA
QUALITY
GUARANTEE
MADE IN
SPAIN

		Color Colour
REF. 01090 ●		□

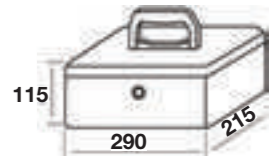

De gran utilidad para
USO PROFESIONAL
PROFESSIONAL USE

+ COMPARTIMENTOS JOMA EURO 1 CASHIERS

Para cajas
Joma
Euro SIN
soporte/
For Boxes
Joma Euro
WITHOUT
support



REF. 50022 ●

Para cajas
Joma Euro
CON soporte
/ For Boxes
Joma Euro
WITH support



REF. 50023 ●

OFFICE 1



OFFICE 1 / 4 columns x 25 filas / Envolente 15 mm interior / Todo pintura INOX
OFFICE 1 / 4 columns x 25 rows / Indoor surround 15 mm / All in INOX paint



Opcional con bocacarta o puerta ciega.
Flap or blind box optional.

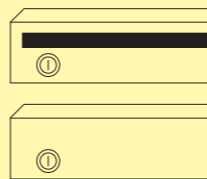

JOMA QUALITY GUARANTEE
MADE IN SPAIN



PERSONALIZACIÓN / CUSTOMIZATION

JomaColor P. 94

COMPLEMENTOS
OPTIONS FOR BANKS

ROTULACIÓN LÁSER
LASER ENGRAVING

CERRADURA
LOCK

	Descripción Description	Acabado Finish	Dimensiones Dimensions
Ref. 24777	CASILLERO OFFICE 1 (CON BOCACARTAS / WITH FLAP)	Todo pintura INOX All in INOX paint	240 x 60 x 250 mm
Ref. 24778		Pintura INOX-INOX brillo AISI 430 INOX paint-S. Steel Gloss AISI 430	
Ref. 90323		JomaColor (MÍNIMO/MINIMUM: 20 UDS.)	
Ref. 24779	CASILLERO OFFICE 1 (SIN BOCACARTAS / WITHOUT FLAP)	Todo pintura INOX All in INOX paint	
Ref. 24780		Pintura INOX-INOX brillo AISI 430 INOX paint-S. Steel Gloss AISI 430	
Ref. 90324		JomaColor (MÍNIMO/MINIMUM: 20 UDS.)	

*Precio unitario por puerta. Consultar mínimos. *Unit price per door. Check minimum quantity.

OFFICE 2



OFFICE 2 / 5 columnas x 10 filas / Con envolente 15 mm interior / Pintura INOX-INOX brillo AISI 430
OFFICE 2 / 5 columns, 10 rows / Indoor surround 15 mm. INOX paint-Stainless Steel Gloss AISI 430



OFFICE 2 / 3 columnas x 3 filas / Envolente 15 mm interior / Todo pintura INOX
OFFICE 2 / 3 columns x 10 rows / Indoor surround 15 mm / All in INOX paint

JOMA QUALITY GUARANTEE
MADE IN SPAIN



PERSONALIZACIÓN / CUSTOMIZATION

JomaColor P. 94

COMPLEMENTOS
OPTIONS FOR BANKS

ROTULACIÓN LÁSER
LASER ENGRAVING

CERRADURA
LOCK

	Descripción Description	Acabado Finish	Dimensiones Dimensions	
Ref. 24781	CASILLERO OFFICE 2-1340	Todo pintura INOX All in INOX paint	130 x 130 x 400 mm	
Ref. 24782		Pintura INOX-INOX brillo AISI 430 INOX paint-S. Steel Gloss AISI 430		
Ref. 90325		JomaColor (MÍNIMO/MINIMUM: 20 UDS.)		
Ref. 24783	CASILLERO OFFICE 2-1538	Todo pintura INOX All in INOX paint		150 x 150 x 380 mm
Ref. 24784		Pintura INOX-INOX brillo AISI 430 INOX paint-S. Steel Gloss AISI 430		
Ref. 90326		JomaColor (MÍNIMO/MINIMUM: 20 UDS.)		

*Precio unitario por puerta. Consultar mínimos. *Unit price per door. Check minimum quantity.

OFFICE 3 / N1-N2



PERSONALIZACIÓN / CUSTOMIZATION

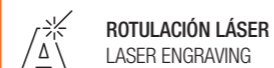

OFFICE 3 N1-N2 / 5 columnas x 3 filas / Todo Blanco
OFFICE 3 N1-N2 / 5 columns x 3 rows / All in White

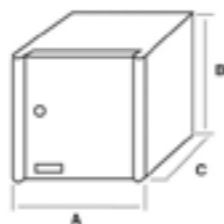

	Descripción Description	Acabado Finish	Dimensiones Dimensions
Ref. 90130	OFFICE 3 / N1	Todo Blanco All in White	404 x 390 x 255 mm
Ref. 24733		JomaColor (MÍNIMO/MINIMUM: 10 UDS.)	
Ref. 90140	OFFICE 3 / N2	Todo Blanco All in White	404 x 390 x 385 mm
Ref. 90327		JomaColor (MÍNIMO/MINIMUM: 10 UDS.)	

***Precio unitario por puerta *Unit price per door.**

OFFICE 4 IDEAL PARA PORTÁTILES Y DOCUMENTOS DE OFICINA SUITABLE FOR LAPTOPS AND OFFICE DOCUMENTS



PERSONALIZACIÓN / CUSTOMIZATION



La respuesta al cambio digital en la enseñanza. Los libros se van sustituyendo por ordenadores y tablets que los alumnos pueden almacenar en nuestros casilleros. Podemos construir módulos de hasta 22 unidades.

The answer to the digital revolution on education. Books are being replaced by laptops and tablets that students can keep inside the lockers. We can build modules up to 22 units.



Office 4 de 13 puertas, con envolvente y colores personalizados.
13 doors Office 4 with surrounding and customized colors.

El casillero Office 4 se fabrica a medida en una sola pieza, con el nº de puertas necesarias (mínimo de 5 y máximo de 22).

The Office 4 locker is made to measure in one single body, with the nº of doors required (minimum of 5 and maximum of 22).

MEDIDAS POR GRUPO / MEASURES BY GROUP

5	6	7	8	9	10	11	12	13	14	15	16	17	18	19	20	21	22
485	576	667	758	849	940	1031	1122	1213	1304	1395	1486	1577	1668	1759	1850	1941	2032

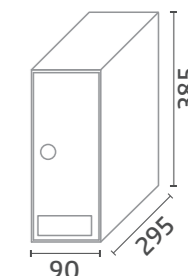

	Acabado Finish
Ref. 90105	Pintura INOX INOX paint
Ref. 90106	JomaColor (MÍNIMO/MINIMUM: 1 UDS.)

***Precio unitario por puerta *Unit price per door.**

OFFICE 5 GUARDAMÓVILES
SMARTPHONE LOCKERS



Gris Forja / Forging Grey

4

MÓDULOS/MODULES



Pintura INOX / INOX Paint

5

MÓDULOS/MODULES



Gris Forja / Forging Grey

6

MÓDULOS/MODULES



PERSONALIZACIÓN / CUSTOMIZATION



P. 94

DIMENSIONES / DIMENSIONS

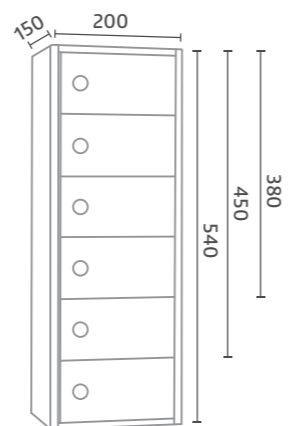

JomaEquip

Equipamiento para la comunidad

Equipment for collectivities

MÓDULOS / MODULES	COLOR / COLOUR	CERRADURA ESTÁNDAR / STANDARD LOCK	CERRADURA COMBI / COMBI LOCK
4	Gris forja / Forging grey	24622	24819
	Pintura INOX / INOX paint	24619	24820
	JomaColor (MÍNIMO/MINIMUM: 5 uds.)	24625	24625C
5	Gris forja / Forging grey	24623	24821
	Pintura INOX / INOX paint	24620 ●	24822
	JomaColor (MÍNIMO/MINIMUM: 5 uds.)	24626	24626C
6	Gris forja / Forging grey	24624	24823
	Pintura INOX / INOX paint	24621	24824
	JomaColor (MÍNIMO/MINIMUM: 5 uds.)	24627	24627C

RECOGEPUBLICIDAD
PUBLICITY BOXES

MADE IN SPAIN

1/2 MODELO
MODEL



3 MODELO
MODEL



4 MODELO
MODEL



5/6 MODELO
MODEL



Modelo Model	Color Colour	Medidas Exteriores External Dimensions A x B x C (mm)
1	05030 ●	Negro/Black
	05031 ●	Blanco/White
	05034 ●	INOX AISI 430 Brillo/S. Steel Gloss AISI 430 ●
	05051 ●	Pintura INOX / INOX Paint
	24720 ●	JomaColor
2	05040 ●	Negro/Black
	05041 ●	Blanco/White
	05044 ●	INOX AISI 430 Brillo/S. Steel Gloss AISI 430 ●
	05061 ●	Pintura INOX / INOX Paint
	24721 ●	JomaColor
3	05080 ●	Negro/Black
	05084 ●	Blanco/White
	05085 ●	Pintura INOX / INOX Paint
	24722 ●	JomaColor
4	05062 ●	Negro/Black
	05063 ●	Blanco/White
	05065 ●	Pintura INOX / INOX Paint
	24723 ●	JomaColor
5	05011 ●	Blanco/White
6	05021 ●	Blanco/White



PERSONALIZACIÓN / CUSTOMIZATION



MÍNIMO/MINIMUM: 20 uds.



PAPELERAS EXTERIORES
OUTDOOR WASTE BINS

MADE IN SPAIN

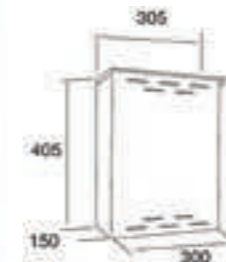

REF. 05004 ●
Negro / Black

REF. 05054 ●
Rojo / Red

REF. 05008 ●
Pintura INOX / INOX Paint

REF. 24725 ●
JomaColor



PERSONALIZACIÓN / CUSTOMIZATION



MÍNIMO/MINIMUM: 15 uds.

PAPELERAS INTERIORES
INDOOR WASTE BINS

MADE IN SPAIN



REF. 05000 ●
Negro / Black

REF. 05053 ●
Rojo / Red

REF. 05003 ●
Pintura INOX / INOX Paint

REF. 24725 ●
JomaColor



PERSONALIZACIÓN / CUSTOMIZATION



MÍNIMO/MINIMUM: 15 uds.

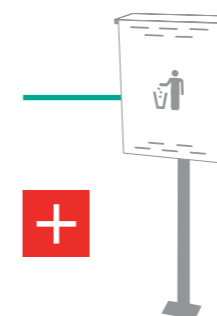

SOPORTE PAPELERA / WASTE BIN SUPPORT

Puedes añadir un soporte a tu papelera.

You can add a support to your waste bin.

REF. 05013

- Para atornillar al suelo (0,80 m de altura).
- To be screwed to the floor (0,80 m high).
- Tubo para enterrar/Support to ground: h=1000 mm.
- Base/Base: 130 x 130 x 5 mm.

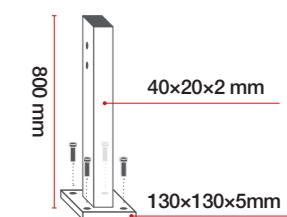

BARCELONA PAPELERA WASTE BIN

MADE IN SPAIN



AISI 304 MATE

60 LITROS LITERS

REF. 05049 ●

Papelera Barcelona INOX Mate AISI 304
Barcelona waste bin Stainless Steel Matt AISI 304

**El precio puede variar, consultar con Joma.
The price may vary, check with Joma.

- Papelera de acero.
- Capacidad 60 litros.
- Ancho 475 mm x Alto 884 mm x Diámetro ø 381 mm
- Basculante.
- Color Inox Aisi 304 Mate.
- Acabado: Pintado.
- Fijación: Sobre base.
- Steel bin.
- Capacity 60 liters
- Width 475 mm x Height 884 mm x Diameter ø 381 mm
- Tilt.
- Stainless Steel AISI 304 Matt colour.
- Finish: Painted.
- Fixing: In top of a base.

Se suministra sin montar. (Soporte + cesta).
The bin is supplied unassembled. (Support + basket).

CENICEROS ASHTRAYS

MADE IN SPAIN

1

MODELO / MODEL



A



REF. 53150 ●

Negro / Black

REF. 24727

JomaColor

2

MODELO / MODEL



A

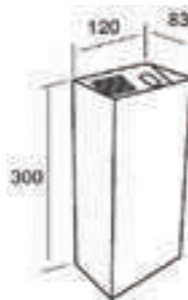

REF. 53188 ●

Negro / Black

REF. 24728

JomaColor

PERSONALIZACIÓN / CUSTOMIZATION



MÍNIMO/MINIMUM: 15 uds.

ARCO APARCABICIS BIKE RACKS

MADE IN SPAIN



AISI 304 MATE

AG

1x

INOX AISI 304 / S. STEEL 304 AISI

1150 mm x 850 mm (ø 50mm, espesor/ thickness 1,5 mm)

REF. 24737 | CONSULTAR / CHECK WITH JOMA

ACERO GALVANIZADO GALVANIZED STEEL

1150 mm x 850 mm (ø 50mm, espesor/ thickness 1,5 mm)

REF. 24738 | CONSULTAR / CHECK WITH JOMA

Solicitar opción para enterrar /
Optional: fixing into concrete

PIN APARCABICIS BIKE RACKS

MADE IN SPAIN



A

3x

900 mm x 300 mm

PIN 3

REF. 24735 ●

2x

850 mm x 300 mm

EXTENSIÓN PIN 2

REF. 24734 ●

5x

1700 mm x 300 mm

PIN 5 (3+2)

REF. 24736

DOM APARCABICIS BIKE RACKS

MADE IN SPAIN



5x

2400 x 820 x 300 mm

DOM

REF. 24737



ESPEJOS EXTERIOR
OUTDOOR MIRRORS



MADE IN ITALY



Ø 600 mm

REF. 53053 ●

Espejo para exterior ø600
Mirror for outdoor ø600

Ø 800 mm

REF. 53054 ●

Espejo para exterior ø800
Mirror for outdoor ø800

Acrílico / Incluye fijación a poste redondo.

Acryl / Fixing to round post included.

ESPEJOS INTERIOR
INDOOR MIRRORS



MADE IN ITALY



Ø 400 mm

REF. 53058 ●

Espejo para interior
Mirror for indoor

Ø 600 mm

REF. 53059 ●

Espejo para interior
Mirror for indoor

Acrílico / Incluye fijación a poste redondo.

Acryl / Fixing to round post included.

+ SOPORTE UNIVERSAL / UNIVERSAL FIXING

Puedes añadir un soporte a tu espejo. Sirve para pared y postes rectangulares 80 x 40 y Ø 60

You can add a support to your mirror. Fits 80 x 40 rectangular wall studs and 60 ø.

REF. 53056 ●

Soporte universal para espejo
Universal fixing for mirror



BOTIQUINES
FIRST AID BOXES

MADE IN SPAIN

Nº 1



REF. 04001 ●

Dimensiones exteriores (A x B x C)
Exterior dimensions (A x B x C)
(300 x 390 x 120 mm)

Nº 2



REF. 04002 ●

Dimensiones exteriores (A x B x C)
Exterior dimensions (A x B x C)
(350 x 475 x 120 mm)

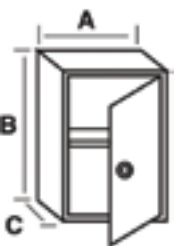

ARENERO Y GUARDATRAPOS
SAND AND RAGS BOXES

MADE IN SPAIN



REF. 05023 ●
Arenero / Sand box

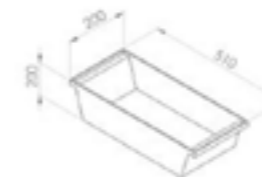

REF. 05025 ●
Guardatrapos / Rag box



PANERA HORIZONTAL
HORIZONTAL BREAD BOX



MADE IN SPAIN



BEST SELLER

REF. 53120 ●
Verde Foresta/Forest Green

REF. 53123
JomaColor

PERSONALIZACIÓN / CUSTOMIZATION



MÍNIMO/MINIMUM: 10 uds.

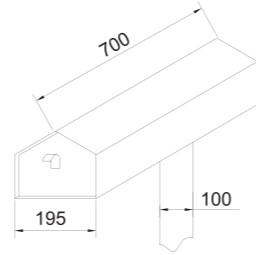

REF. 53140
Poste + Conexión. Verde Foresta
Post + Assembly Plate. Forest Green



REF. 53143
Anclaje suelo. Verde Foresta
Floor anchorage. Forest Green



REF. 53147
Anclaje pared + Conexión. Verde Foresta
Wall mounted support. Forest Green

PANERA VERTICAL
VERTICAL BREAD BOX



MADE IN SPAIN

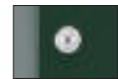

REF. 53290 ●
Verde foresta con cerradura estándar
Forest Green with standard lock

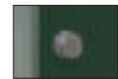

REF. 53292 ●
Verde foresta con pomo
Forest Green with doorknob

REF. 53291
JomaColor



PERSONALIZACIÓN / CUSTOMIZATION



MÍNIMO/MINIMUM: 10 uds.

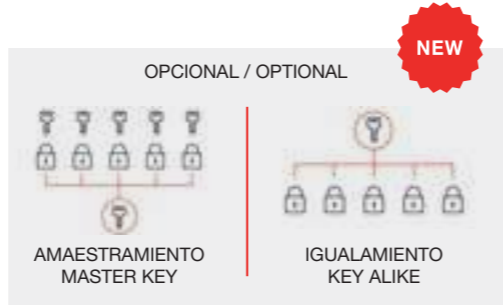

BRISA



REF. 05192 ●
1 Din A4



REF. 05193 ●
2 Din A4



REF. 05194 ●
4 Din A4



PROPIEDADES / PROPERTIES

- El perfil de aluminio cubre el marco de la puerta ofreciendo un aspecto muy estético.
- Perfil de puerta de metacrilato de 5 mm de espesor.
- Incluye imanes.
- The high quality extruded Aluminium profile covers the door frame offering a very beautiful appearance.
- Door made of 5 mm thick methacrylate.
- Includes magnets.

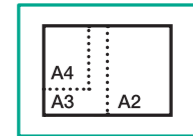

DIFERENTES TAMAÑOS
DIFFERENT DIMENSIONS

DIMENSIONES / DIMENSIONS

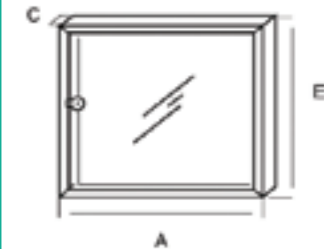

- 1 Din A4: 260 x 350 x 40 mm
- 2 Din A4: 480 x 360 x 40 mm
- 4 Din A4: 480 x 670 x 40 mm



GALAXIA



2 REF. 05262 ●
2 Din A4



4 REF. 05264 ●
4 Din A4

BEST SELLER



6 REF. 05266 ●
6 Din A4



8 REF. 05268 ●
8 Din A4

REF. 05266 ●
Imán para paneles de información



PROPIEDADES / PROPERTIES

- Perfil de Aluminio anodizado de 22 mm de anchura y 2 mm de espesor.
- El perfil de aluminio cubre el marco de la puerta ofreciendo un aspecto muy estético.
- Perfil de puerta de metacrilato de 5 mm de espesor.
- Incluye imanes.

- Anodized aluminium profile 22 mm width and 2mm thick.
- The high quality extruded Aluminium profile covers the door frame offering a very beautiful appearance.
- Door made of 5 mm thick methacrylate.
- Includes magnets.

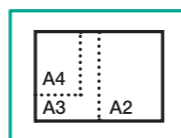

DIFERENTES TAMAÑOS
DIFFERENT DIMENSIONS

DIMENSIONES / DIMENSIONS

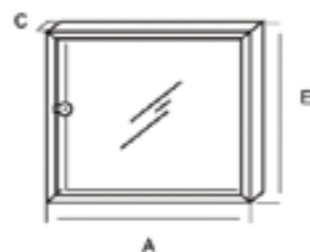

- 2 Din A4: 497 x 364 x 55 mm
- 4 Din A4: 497 x 671 x 55 mm
- 6 Din A4: 717 x 671 x 55 mm
- 8 Din A4: 937 x 671 x 55 mm

GALAXIA EXTERIOR



PROPIEDADES / PROPERTIES

CUBIERTA/ROOF

- Chapa electrocincada de espesor 1,2 mm.
- Electro zinc steel plate, 1.2 mm thick.

PANEL/PANEL

- Chapa electrocincada de espesor 0,7 mm.
- Electro zinc steel plate, 0.7 mm thick.

SOPORTES/SUPPORTS

- Soportes de Hierro 2000 x 60 x 120 mm de 3 mm de espesor.
- 3 mm thick Iron supports, dimensions 2000 x 60 x 120 mm.

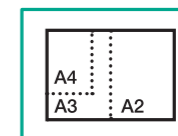

DIFERENTES TAMAÑOS
DIFFERENT DIMENSIONS

PERSONALIZACIÓN / CUSTOMIZATION



DIMENSIONES / DIMENSIONS

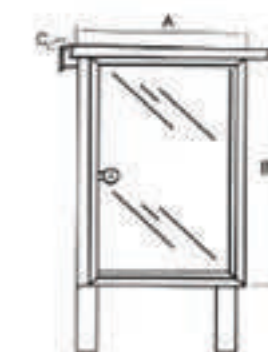

- 4 Din A4: 497 x 671 x 55 mm
- 6 Din A4: 717 x 671 x 55 mm
- 8 Din A4: 937 x 671 x 55 mm



PANELES / PANELS

Acabado Finish	4 DINA4	6 DINA4	8 DINA4
Verde / Green	REF. 05134	REF. 05136	REF. 05138
Óxido / Oxide	REF. 05154	REF. 05156	REF. 05158
JomaColor	REF. 05135	REF. 05137	REF. 05139

SOPORTES / SUPPORTS

2 soportes verde 2 green supports REF. 53191	2 soportes Óxido 2 oxide supports REF. 53193	2 soportes JomaColor 2 JomaColor supports REF. 53209
--	--	--

PANEL LED DAY



TECNOLOGÍA LED
LED TECHNOLOGY

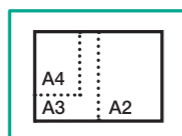

DIFERENTES TAMAÑOS
DIFFERENT DIMENSIONS



PROPIEDADES / PROPERTIES

Los paneles Day permiten presentar información y carteles publicitarios de diversos tamaños de forma llamativa y visual.

The Day display cases enables you to display information and advertising posters of various sizes in an eye-catching and visual way.

DIMENSIONES / DIMENSIONS

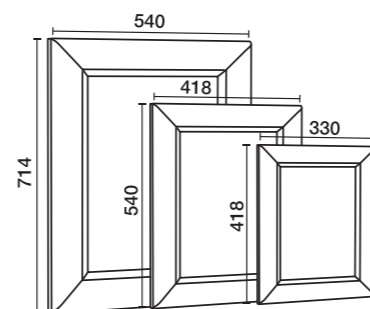

REF. 24582 ●
4 Din A4



REF. 24580 ●
2 Din A4



REF. 24578 ●
1 Din A4

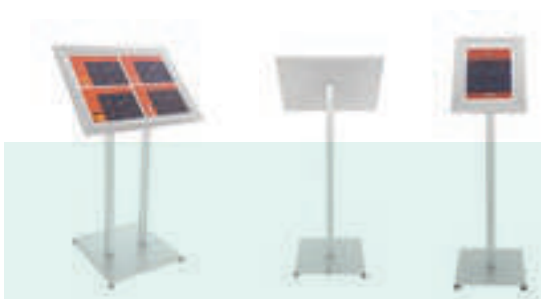

ATRIL OPCIONAL
consultar con Joma

Optional
check with Joma

MOON



GRAN ESTANQUEIDAD
WATERTIGHT



TECNOLOGÍA LED
LED TECHNOLOGY

REF. 24584 ●

PROPIEDADES / PROPERTIES

Vitrina de exterior a prueba de agua retroiluminada con luz LED. Una solución elegante para hacer visible la información en fachada.

Waterproof outdoor display case backlit with LED light. An elegant solution for displaying information on the front of buildings.

DIMENSIONES / DIMENSIONS

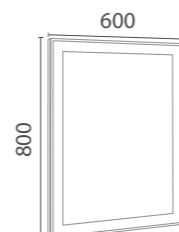

Cerraduras y Recambios

Locks and spare parts

Cerraduras / Locks

CERRADURA / LOCK	REF.	MODELO / MODEL
 n°1	51010	VINTAGE / EURO VINTAGE
 n°32	51015	ARMARIO STANDARD 20-30-42-70 / CENICERO 2
 n°7	51016	LENGÜETA RECTA / STRAIGHT CAM
 n°7 SP	51016P	EVEREST / EVEREST MINI / K2 / ARMARIO PRO PLUS 300 (LENGÜETA RECTA/ STRAIGHT CAM)
 n°7 SP CON FABELLA	51016PF	PRO PLUS 400-1200
 n°8	51017	SUPER JOMA / CAJA LLAVE EMERGENCIA / CAJAS EURO 1
 n°9	51018	EUROBOX
 n°10	51019	HALL 10 / GARDEN 50-51-51E / LOBBY
 n°11 CL	51020CL	COLUMN V / HALL 20-23-24 / ARTICO PUSH / GARDEN 52-53-54 / RC N1-N2 / BOTIQUÍN 1-2 / ARMARIO PROFESIONAL / BUZÓN EMERGENCIA / EVO 40 / OFFICE 5
 n°11 Serie PLUS	51020P	BCP MARINE / COLUMN H

Cerraduras / Locks

CERRADURA / LOCK	REF.	MODELO / MODEL	
 n°15	51028	GARDEN 70 / ARCO / AZ90	
 n°17	51082	PANEL GALAXIA / ARMARIO 51 LLAVES	
 n°20	51033	STONE PUSH	
 n°21 CL	51034CL	HORIZON / OCEAN EVO /KOMPACT (H/V/DC) / WALL / PANERA VERTICAL / MAGNUM / IRIS 500 / IRIS 1000 / MAGNUM	
 n°21 SP	51034P	KOMPACT EVO XL / KOMPACT EVO / KOMPACT EVO ALU / MARITIME PLUS / KOMPACT MARINE / HORIZON MARINE	
 n°23	51039	COSMOS FRONT / COSMOS TOP	
 n°34	51039CL	COSMOS PUSH	
 n°24	51040CL	INDICO / LINE	
-	MULTI	51077	GARDEN 01 / GARDEN 02 / GARDEN 40
 BRISA LLAVES IGUALES	51078	BRISA LLAVES IGUALES	
-	BASIC 500	51079	AIR RC / VERTIK RC / EVO 10
-	VINTAGE	51080	VINTAGE 2019
 PLUS PBOX	51081	EVEREST MINI PBOX / K2 PBOX	

Cerraduras / Locks

CERRADURA / LOCK	REF.	MODELO / MODEL	
 CANDADO KOMPACT	51034CAN	KOMPACT H	
 POMO	51045	VARIOS / VARIOUS	
-	OPEN AIR	51075	OPEN AIR
 ELECTRÓNICA GEMINIS	51088	VARIOS / VARIOUS	
 ELECTRÓNICA RAS	EK501BEL	PRO PLUS	
 COMBI ROUND	MK501BCR	PROFESIONAL / PRO PLUS / CASILLEROS	
 COMBI MK	51071	KOMPACT / OFFICE 5 COMBI	

	RECARGO CERRADURA AMAESTRADA MK	51057
	RECARGO CERRADURA LLAVES IGUALES KA	51058

		
PLUS	AGA	MULTIUSOS
24800	24799	24802

Llaves / Keys

REF.	MODELO / MODEL
51075LL	LLAVE CERRADURA OPEN AIR
52009	LLAVE MAESTRA MK AGRUPACION DE BUZONES
51071MK	LLAVE MAESTRA COMBI4 MK
EK501BEL-MK	LLAVE MAESTRA PARA CERRADURA ELECTRÓNICA RAS NEW!
MK501BCR-MK	LLAVE MAESTRA PARA CERRADURA COMBI ROUND NEW!
52002	LLAVE EN BRUTO - UNIDAD
52002A5	LLAVE EN BRUTO A500
52002A9	LLAVE EN BRUTO A900
52002B5	LLAVE EN BRUTO B500
52002B9	LLAVE EN BRUTO B900
52002C5	LLAVE EN BRUTO C500
52002C9	LLAVE EN BRUTO C900
52002D5	LLAVE EN BRUTO D500
52002D9	LLAVE EN BRUTO D900
52002E	LLAVE EN BRUTO EUROLOCK A/B
52003	LLAVE DENTADA AGA (JUEGO DE 2)
52004	LLAVE DENTADA SERIE PLUS (JUEGO DE 2)

Tarjeteros / Nameplates

TARJETERO / NAMEPLATE	REF.	MODELO / MODEL
	T1 52005	KOMPACT H//DC/PUSH/COLUMN H//ARTICO/HALL DC/HORIZON/OCEAN EVO/GARDEN 52/53/54-MARE/EVO 40
	T2 03070TAR	HALL/LOBBY/INDICO/GARDEN 51/GARDEN 50/BOCACARTAS 265/EVO 10/VERTIK/AIR/SEKKEI
	T3 09600TAR	GARDEN 03/GARDEN 30/GARDEN 01
	T4 08595TAR	COSMOS FRONT/TOP/AZ
	T5 09650TAR	COSMOS PUSH 320
	T6 80000TAR	ARCO
	T7 80010TAR	GARDEN 70
	T9HQ 03171TAR	KOMPACT EVO/KOMPACT ALU EVO/MARITIME

Varios / Various

REF.	MODELO / MODEL
24502BOL	BOLSA 20 RECAMBIOS REMACHES PLASTICO TBC KOMPACT SET OF 20 PLASTIC RIVETS REPLACEMENT - FLAP WALL
81000BOL	BOLSA 10 (BISAGRA+PASADOR) KOMPACT / SET 10 (HINGE+PIN) WALL
52011	TACOS UNIÓN METÁLICOS PARA BUZONES (TORNILLO + TUERCA, 4 UNID) METALLIC KIT FOR MAILBOX UNION (SCREW + NUT, KIT OF 4)
01018	KIT 4 TAPONES PLASTICO UNION BUZONES / PLASTIC FIXING FOR MAILBOX UNION (KIT OF 4UNITS)



Grabación Láser

Laser engraving

Podemos personalizar tu producto mediante grabación láser. Puedes añadir tu nombre, el número de tu vivienda o incluso logotipos.

*Consultar mínimos y precios.

Customize your product with laser engraving. You can add your name, house number or even logotypes.

*Check conditions and prices.



Opción de grabación de logotipos. Consultar con Joma.

Logotypes engraving option. Check with Joma.



Grabación láser / Laser engraving

Personalice su producto mediante grabación por láser. Letra tipo "Arial", Altura 12 mm (Opcional otro tipo de letra y altura).

Customize your product with laser engraving. "Arial" font, height 12 mm (Optional, different height and font).

Hasta 4 caracteres Up to 4 characters	Ref. 53390
De 5 a 11 caracteres From 5 to 11 characters	Ref. 53391

Satinados / Satin finish

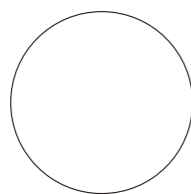

BLANCO NIEVE
SIGNAL WHITE
RM 9003

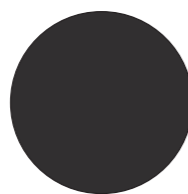

NEGRO MATE
MATT BLACK
RM 9005

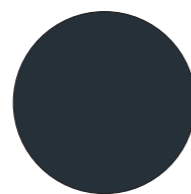

GRIS ANTRACITA
ANTHRACITE GREY
RM 7016

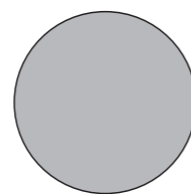

PLATA
SILVER
RX 9006 XW

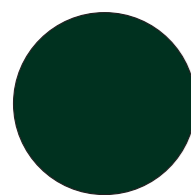

VERDE FORESTA
FOREST GREEN
RM 6009

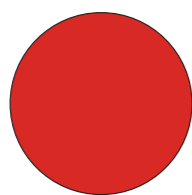

FERRARI
FERRARI
RM 3020

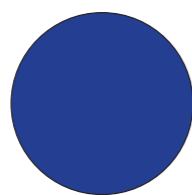

AZUL
BLUE
RB 5002

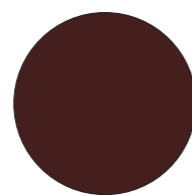

MARRÓN
BROWN
RB 8017

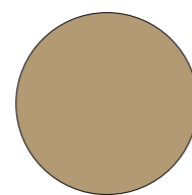

ARENA
SAND
RM 1019

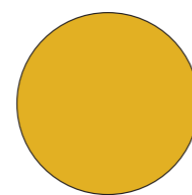

MOSTAZA
MUSTARD
RB 1005

Antihuellas / Anti-fingerprints

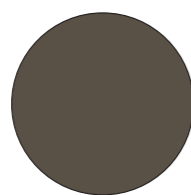

BRONCE METEORITE
METEOR BRONZE
RX 1541 XW

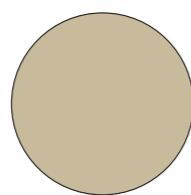

NÁCAR
NACRE
RX 7190 XW

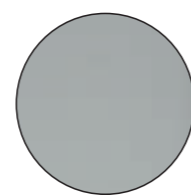

INOX
INOX PAINT
RX 7584 XW

Texturados / Textured

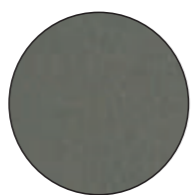

GRIS FORJA
FORGING GREY
RF 7126 XW

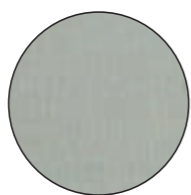

GRIS TEXTURADO
TEXTURED GREY
RF 9007 XW



ÓXIDO MEXICAN
MEXICAN OXIDE
RT 8107 I

INFORMACIÓN ÚTIL

USEFUL INFORMATION



Jose María Gallastegui y Cía., S. A.
San Bartolomé, 11-Poligono Industrial Goain
01170 LEGUTIO (Araba) SPAIN

Tel. (+0034) 945 318770/71/72
Fax: (+0034) 945 465900
e-mail: joma@joma.es

joma.es



CONDICIONES DE ENVÍO

Los portes serán pagados para envíos superiores a los siguientes valores netos en factura según zonas:

- España (península): 300€
- Andorra + Baleares: 400€
- Islas Canarias: (CFR Tenerife y Las Palmas): 850€
- Ceuta y Melilla: 850€
- Portugal: 650€

En el caso de no superar la franquicia de portes, el envío se podrá realizar con los siguientes importes cargados en factura:

- España (península): 15€
- Andorra + Baleares: 30€
- Islas Canarias, Ceuta y Melilla: Debidos
- Portugal: 35€

*OTROS PAISES: CONSULTAR

*PLEASE ASK FOR SHIPPING CONDITIONS FOR OTHER COUNTRIES.



DEVOLUCIONES PRODUCTO

- Joma deberá AUTORIZAR la devolución de la mercancía, asignando un número tras la aprobación. Este número deberá de ser visible en la devolución.
- No se admitirán cargos contables sobre mercancías devueltas o defectuosas. Siempre será Joma quien emita la factura abono.
- No se admitirán devoluciones de producto descatalogado y/o personalizado.

DEVOLUCIONES POR CAUSAS IMPUTABLES AL CLIENTE

Solo se abonarán las devoluciones de producto que estén en perfecto estado. Se ofrecerán 2 opciones teniendo en cuenta los gastos de gestión, revisión, cambio de embalaje, etc.:

1. Abono (euros) del 80% del precio de compra. (devolución sin reposición)
2. Valoración (euros) del 90% del precio compra, con pedido de mercancía a reponer (devolución con reposición). El coste del transporte del envío de la mercancía a Joma, siempre será a cargo del cliente.

DEVOLUCIONES POR CAUSAS IMPUTABLES A JOMA

- Joma se hará cargo de la retirada y reposición de la mercancía.
- Sólo se admitirán devoluciones imputables a Joma sobre producto facturado hasta los 30 días naturales siguientes al envío de esta mercancía.

RECLAMACIONES DE TRANSPORTE

El cliente deberá asegurarse del perfecto estado de la mercancía antes de firmar el albarán de entrega. Disponemos de 24 horas para trasladar esta reclamación a la empresa de transporte. Es primordial que venga acompañada de fotografía.

INFORMACIÓN DEL CATÁLOGO – NO TIENE CARÁCTER CONTRACTUAL

Toda la información que aparece en este catálogo, tiene carácter informativo, pero no contractual. En JOMA nos reservamos la facultad de realizar modificaciones y mejoras en nuestros productos.

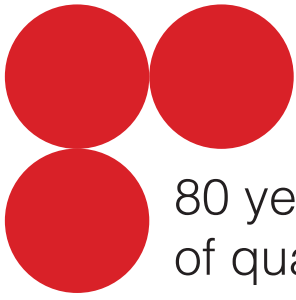

80 years
of quality

REF. CATÁLOGO / CATALOGUE REF.: DIN A4 | 95013 · DIN A5 | 95010

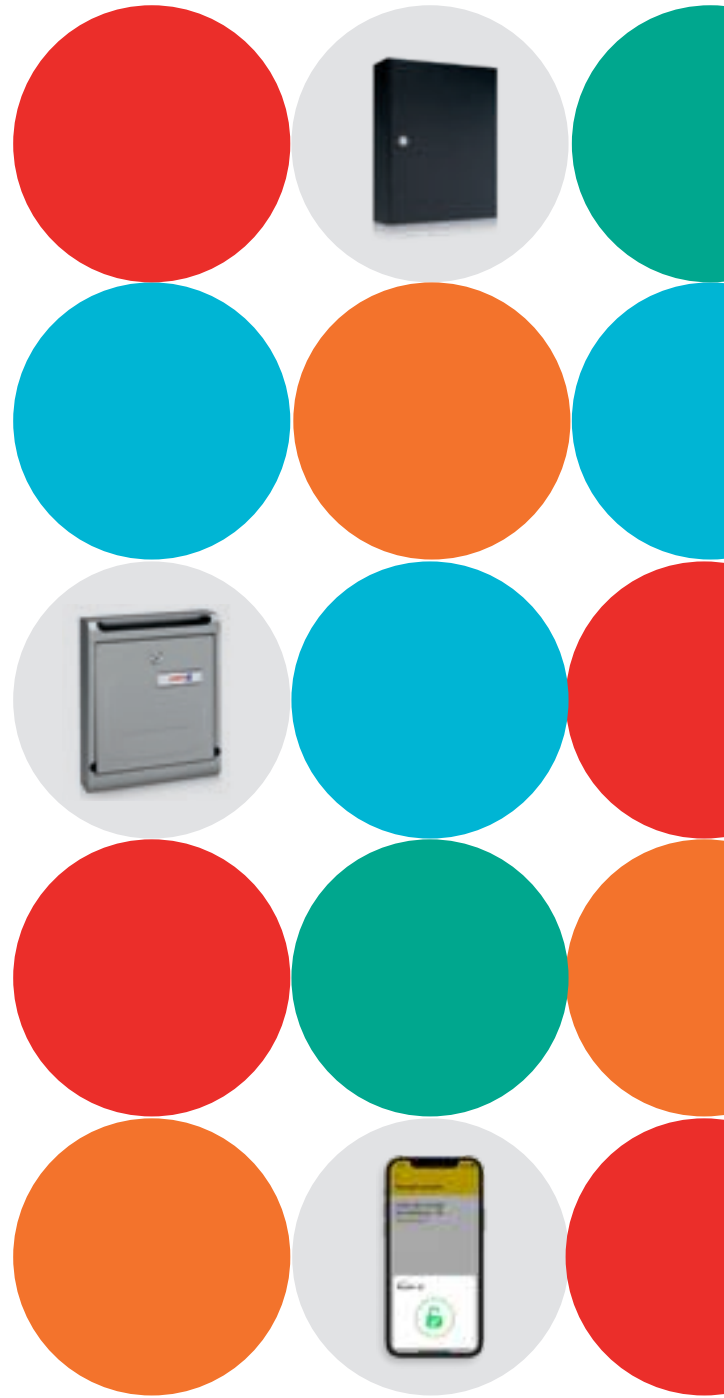

Jose María Gallastegui y Cía., S.A.
San Bartolomé, 11 - Polígono Industrial Goiain.
01170 Legutio (Araba) SPAIN
T. (+34) 945 31 87 70 · joma@joma.es
joma.es



@jomabox_iiot

JOMA
QUALITY
GUARANTEE
**MADE IN
SPAIN**

**100% DISEÑADO
Y FABRICADO EN
VITORIA-GASTEIZ (ESPAÑA)**
100% DESIGNED AND
MANUFACTURED IN
VITORIA-GASTEIZ (SPAIN)